



NATIONAL RESEARCH COUNCIL OF ITALY  
INSTITUTE OF MARINE SCIENCES (BOLOGNA)  
IFREMER (BREST) INGV (ROME)  
ITU-EMCOL (ISTANBUL)

MARM2009:

MARINE GEOLOGICAL STUDY OF THE NORTH ANATOLIAN  
FAULT BENEATH THE SEA OF MARMARA

EC ESONET MARMARA DEMO MISSION,  
R/V URANIA, 2009-09-23, 2009-10-12, CRUISE REPORT

Gasperini Luca, Geli Luis, Favali Paolo,  
Çağatay Namık, Görür Naci

and

ISMAR-CNR, Bologna,



IFREMER, Brest,

**Ifremer**

INGV, Rome,



**INGV**

ITU-EMCOL, Istanbul



MTA, Ankara,



COMU, Cannakale



onboard teams.

ISMAR Bologna TECHNICAL REPORT

*Bologna, November 2009*

Many of the designations used by the manufacturers and sellers to promote their products are claimed as trademarks. Where those designations appear in the Report and ISMAR-CNR was aware of a trademark claim the designations have been printed in all caps. In addition, we have reported some of them in the Production Notes below in this page and in the ACRONYM table thereafter.

Nothing in this document is meant to imply any endorsement or recommendation, positive or negative, concerning any systems or programs mentioned herein.

The data presented hereafter is the property of CNR and of the Joint Research Program. Unauthorized use of the data would be considered unfair.

Many of the systems and programs used to generate data are 'free' because either they are either public domain or the licences are roughly equivalent to the GNU Public License. Some programs are either commercial or have more restrictive licenses and may require payment. Where known, programs and systems that are not 'free' are acknowledged.

#### ISMAR-CNR Cataloging-In-Publication data: ISMAR Bologna TECHNICAL REPORT

Marm2009: marine geological study Of The North Anatolian Fault beneath The Sea Of Marmara. Ec Esonet Marmara Demo Mission, R/V Urania, Cruise Report.

by Gasperini L., Geli L., Favali P., Çağatay N., Görür N., Bortoluzzi G., Del Bianco F., Kuruoglu E., Romano S., Etiope G., Innocenzi L., Marinaro G., Approioul R., Le Piver D., Pelleau P., Roudaut M., Acar D., Akarsu E., Akkok R., Biltekin D., Can A., Elbeck S., Ozmaral A., Ozeren S., Sancar E., Ulgen U., Cefalogli L, Veditti V..

Includes bibliographical reference and index.

1. tectonics 2. active faults 3. paleoseismology 4. seismology 5. Sea of Marmara

**Abstract** - A marine geological cruise, MARMARA2009, was carried out in the frame of MARM-ESONET, a demo mission of the EC funded ESONET Network of Excellence (European Seafloor Observatory Network). Main objective of the project was the attempting to assess and mitigate seismic hazards in the region close to Istanbul through geological/geophysical surveys carried out in the Sea of Marmara along the submerged track of the North Anatolian Fault and the deployment of seafloor observatories. During MARMARA2009 we collected multibeam bathymetry, side-scan sonar imagery and chirp sub-bottom data, together with carefully positioned core samples. A submarine station of the GEOSTAR family (SN-4), 10 OBS and 5 piezometers were deployed on bottom, for recording periods up to 1 year. Although selected prior of the cruise, the SN4-observatory site has been surveyed before deployment with geophysical imaging techniques and direct groundtruthing with a deep towed system, the MEDUSA, that provided oceanographic data (CTD), methane content in the water column and visual inspection through a high-resolution video camera.

**Sommario** - Vengono presentati le metodologie e l'insieme dei risultati ottenuti durante la campagna MARM2009 di rilievi geofisici, geologici e oceanografici nel Mar di Marmara. E' stata utilizzata la nave da ricerca *R/V Urania* del CNR,

Reproduced by ISMAR-CNR from camera-ready proofs supplied by the authors.

Available in the HTML and PDF formats. Available also in other formats, upon request.

Hereafter a link to verbatim copy of this document (LATEX).

Copyright © 2009 by ISMAR-CNR - Via Gobetti 101 40129 Bologna, Italy.

Production Notes - The document was edited with standard text editors, typeset with L.Lamport's  $\LaTeX$ , translated to PostScript with `dvips` and printed with an A4 laser printer. The full production was done on a Linux box with GNU-GPL software. Converted to HTML by N.Drakos's  $\LaTeX$ 2HTML and to PDF by Alladin Ghostscript's `ps2pdf`. Most of the maps included were produced by Wessel and Smith's GMT package. Some drawings were produced by `xfig` ([www.xfig.org](http://www.xfig.org)). Non PostScript images were converted by John Bradley's `xv` or other public-domain packages, among them `convert`.

## ACRONYMS

ACRONYM	DESCRIPTION	URL-email
ESONET	European Seas Observatory NETwork	<a href="http://www.esonet-noe.org/about_esonet">www.esonet-noe.org/about_esonet</a>
ESONET-NOE	ESONET Network of Excellence	<a href="http://www.esonet-noe.org">www.esonet-noe.org</a>
CNR	Consiglio Nazionale Delle Ricerche	<a href="http://www.cnr.it">www.cnr.it</a>
ISMAR	Istituto di Scienze Marine	<a href="http://www.bo.ismar.cnr.it">www.bo.ismar.cnr.it</a>
ISTI	Ist.Scienza e Informazione	<a href="http://www.isti.cnr.it">www.isti.cnr.it</a>
IFREMER	Institute Franc.Exploit. Mer	<a href="http://www.ifremer.fr">www.ifremer.fr</a>
INGV	Istituto naz. geofisica e Vulcanologia	<a href="http://www.ingv.it">www.ingv.it</a>
ITU	Istanbul Technical University	<a href="http://www.itu.edu.tr">www.itu.edu.tr</a>
EMCOL	Eastern Mediterranean Center for Oceanography and Limnology	<a href="http://www.mines.itu.edu.tr/emcol/">www.mines.itu.edu.tr/emcol/</a>
MTA	Maden Tetkik ve Arama Genel Mudurlugu	<a href="http://www.mta.gov.tr">www.mta.gov.tr</a>
COMU	Cannakale Onsekiz Mart Universitesi	<a href="http://www.comu.edu.tr">www.comu.edu.tr</a>
SHODB	Seyir, Hidrografi ve Osinografi Dairesi Baskanligi	<a href="http://www.shodb.gov.tr">www.shodb.gov.tr</a>
KOERI	Kandilli Obs.Earthquake Res.Institute	<a href="http://www.koeri.boun.edu.tr">www.koeri.boun.edu.tr</a>
SEG	Soc. of Exploracion Geophysicists	<a href="http://www.seg.org">www.seg.org</a>
XTF	Extended Triton Format	<a href="http://www.tritonelics.com">www.tritonelics.com</a>
UNESCO	United Nations Scient. and cultural org.	<a href="http://www.unesco.org">www.unesco.org</a>
IOC	Intergov. Oceanogr. Comm. of UNESCO	<a href="http://ioc.unesco.org">ioc.unesco.org</a>
IHO	Int. Hydrographic Organization	<a href="http://www.iho.org">www.iho.org</a>
GPS-DGPS-RTK	Global Positioning System	<a href="http://samadhi.jpl.nasa.gov">samadhi.jpl.nasa.gov</a>
DTM	Digital Terrain Model	<a href="http://en.wikipedia.org">en.wikipedia.org</a>
SRTM	Shuttle Radar Topogr.Mission	<a href="http://www2.jpl.nasa.gov/srtm">www2.jpl.nasa.gov/srtm</a>
OBS	Ocean Bottom Seismometer	<a href="http://woodshole.er.usgs.gov/operations/obs">woodshole.er.usgs.gov/operations/obs</a>
MBES	MULTIBEAM ECHOSOUNDER SYSTEM	
SBP	Sub Bottom Profiling	
PSU	Practical Salinity Scale	<a href="http://ioc.unesco.org">ioc.unesco.org</a>
XBT	Expendable BathyTermograph	<a href="http://www.sippican.com">www.sippican.com</a>
UTM	Universal Transverse Mercator	
UTC	Universal Time Coordinated	
WGS84	World Geodetic System 1984	
NMEA	National Marine Electronics Association	<a href="http://www.nmea.org">www.nmea.org</a>
SO.PRO.MAR.	Societa' Promozione lavori Marittimi	Fiumicino (Italy)
TECNOMARE	ENI Tecnomare	<a href="http://www.tecnomare.it">www.tecnomare.it</a>
SBE	Sea Bird Electronics	<a href="http://www.seabird.com">www.seabird.com</a>
BENTHOS	Teledyne Benthos	<a href="http://www.benthos.com">www.benthos.com</a>
SIS	Sea Floor Inf. System	<a href="http://www.kongsberg.com">www.kongsberg.com</a>
KONGSBERG	Kongsberg Maritime	<a href="http://www.kongsberg.com">www.kongsberg.com</a>
SERCEL	Sercel	<a href="http://www.sercel.com">www.sercel.com</a>
COMM-TECH	Communication Technology	<a href="http://www.comm-tec.com">www.comm-tec.com</a>
NEPTUNE	Simrad MBES Software	<a href="http://www.kongsberg-simrad.com">www.kongsberg-simrad.com</a>
MB-SYSTEM	MB-SYSTEM	<a href="http://www.ldgo.columbia.edu/MB-System">www.ldgo.columbia.edu/MB-System</a>
GMT	Generic Mapping Tool	<a href="http://gmt.soest.hawaii.edu/gmt">gmt.soest.hawaii.edu/gmt</a>

Table 1: Acronyms of Organizations, Manufacturers and Products

## HOW TO READ THIS REPORT

Section 1 gives the introductory and background information, including some technological and scientific issues of the organization and execution of tasks, whereas section 2 summarizes the cruise operations. Section 3 provides the technical aspects that were involved in the data acquisition and processing. Sections 4 and following discuss the initial results, the on-going data processing and usage, and give concluding remarks. Some data processing procedures that were used in the production of this report along with additional technical details and data are presented in the Appendix.

## ACKNOWLEDGMENTS

Many people contributed to the success of the research cruise (MARM09 *R/V Urania*). We are particularly indebted to the Captain Emanuele Gentile, the officers and crew members of *R/V Urania* for their professionalism and efforts in assuring the success of the cruise. Turkish SHOD is warmly acknowledged for support and encouragement. The project was co-funded by Italian CNR and EU's ESONET.



# Contents

<b>1</b>	<b>INTRODUCTION AND BACKGROUNDS</b>	<b>1</b>
<b>2</b>	<b>CRUISE SUMMARY</b>	<b>4</b>
<b>3</b>	<b>MATERIALS AND METHODS</b>	<b>10</b>
3.1	NAVIGATION AND DATA ACQUISITION . . . . .	10
3.2	OBS . . . . .	12
3.3	PIEZOMETERS . . . . .	13
3.4	SN4 BOTTOM OBSERVATORY . . . . .	17
3.5	MEDUSA TOWED OBSERVATORY . . . . .	19
3.6	SEABED SAMPLING . . . . .	20
3.7	MISCELLANEOUS . . . . .	22
<b>4</b>	<b>DESCRIPTION OF DEPLOYMENTS AND OF DATA COLLECTED</b>	<b>23</b>
4.1	OBS AND PIEZOMETER DEPLOYMENT . . . . .	23
4.2	SN-4 OBSERVATORY DEPLOYMENT . . . . .	23
4.3	MEDUSA PROFILING . . . . .	30
4.4	SEABED SAMPLING . . . . .	32
4.5	CHIRP SBP . . . . .	36
<b>5</b>	<b>CONCLUDING REMARKS AND FUTURE WORKS</b>	<b>39</b>
<b>6</b>	<b>APPENDIX</b>	<b>45</b>
6.1	DIARY OF OPERATIONS . . . . .	45
6.2	POSITIONING MAPS OF MOST RELEVANT OPERATIONS AT SEA . . . . .	46

## List of Figures

1	Sea of Marmara region setting. Bathymetry from Ifremer Atlas [Le Pichon et al.(2005)], DTM from SRTM data (Shuttle Radar Topogr. Mission NASA/ASI) . . . . .	2
2	Morpho-tectonic map of the Darica basin close to the SN4 deployment site. . . . .	3
3	General ship track during Cruise MARM09, including transits from Brindisi and to Messina. Circles with small circle are OBS, rhombs with circle are piezometers, hollows are CTD stations. . . . .	4
4	Ship track during Cruise MARM09 in the Marmara Sea. Circles with small circle are OBS, rhombs with circle are piezometers, hollows are CTD stations. . . . .	5
5	Deployment sites of piezometers and OBS. . . . .	5
6	Navigation in Çınarcıkand İzmitregions. . . . .	6
7	Navigation in İzmitregions. . . . .	6
8	<i>R/V Urania</i> . . . . .	10
9	OBS at launch. . . . .	12
10	Sketch of the Piezometer deployment. . . . .	14
11	Sketch of the Piezometer deployment. . . . .	14
12	Piezometer being prepared on the launch frame. . . . .	15
13	Piezometer being put vertical for launch by the oleopneumatic pistons. . . . .	15
14	Piezometer ready for launch. . . . .	16
15	SN4 sketches. . . . .	18
16	INGV's MEDUSA being deployed. . . . .	19
17	SW-104 water/sediment corer and box corer. . . . .	20
18	Gravity corer. . . . .	21
19	CHIRP profiles relative to the Piezometer's deployment.From left to right, PZ-A, PZ-B, PZ-C, PZ-D, PZ-E. . . . .	23
20	SN-4 being deployed. . . . .	24
21	Map showing the position of the SN4 on bottom (gray circle and cross). Hollow circle is the ship's reference point position. . . . .	25
22	Snapshot of the navigation system's data at the touchdown of SN4. . . . .	26
23	Medusa seeing SN4 . . . . .	27
24	Snapshot of the navigation system's data of the Medusa on top of SN4. . . . .	28
25	The area of SN-4 deployment. . . . .	29
26	3D swath bathymetric map collected after the deployment of station. SN4 is visible (in yellow) at the seafloor. . . . .	29
27	MEDUSA, Darica Canyon site. . . . .	30
28	MEDUSA, Hersek site. . . . .	31
29	MEDUSA, Hersek site. . . . .	31
30	Malacofauna inventory from MBC02, Darica Canyon. . . . .	33
31	Mud Volcano Area, Hersek. Oyster found in the bottom of core.. . . . .	34
32	Example of SEISPRHO SEG-Y SBP processed data. . . . .	37
33	Example of SEISPRHO SEG-Y SBP reprocessed data. . . . .	37
34	Example of SEISPRHO SEG-Y SBP reprocessed data. . . . .	38
35	Example of SEISPRHO SEG-Y SBP reprocessed data. . . . .	38
36	OBS01-LV03- positioning data. . . . .	46
37	OBS02-LV11- positioning data. . . . .	47
38	OBS03-LV02- positioning data. . . . .	48
39	OBS04-LV07- positioning data. . . . .	49
40	OBS05-LV12- positioning data. . . . .	50
41	OBS06-LV09- positioning data. . . . .	51
42	MPZ-01- positioning data. . . . .	52
43	PZ-A- positioning data. . . . .	53
44	OBS07-LV05- positioning data. . . . .	54
45	OBS08-LV08- positioning data. . . . .	55
46	PZ-B- positioning data. . . . .	56
47	MPZ-02- positioning data. . . . .	57

48	OBS09-LV10- positioning data. . . . .	58
49	PZ-C- positioning data. . . . .	59
50	MPZ-03- positioning data. . . . .	60
51	OBS10-LV01- positioning data. . . . .	61
52	MPZ-04- positioning data. . . . .	62
53	PZ-D- positioning data. . . . .	63
54	PZ-E- positioning data. . . . .	64
55	MPZ-05- positioning data. . . . .	65
56	MSN-BC01- positioning data. . . . .	66
57	MSN-BC02- positioning data. . . . .	67
58	MSN-C01- positioning data. . . . .	68
59	MSN-C02- positioning data. . . . .	69
60	MSN-C03- positioning data. . . . .	70
61	SN4- positioning data. . . . .	71
62	SN4-RELEASE positioning data. . . . .	72
63	SN4-RESPONSE-8.90-5.30-142DEG positioning data. . . . .	73
64	SN4-SEEN-FROM-MEDUSA positioning data. . . . .	74
65	MSN-SW01- positioning data. . . . .	75
66	MSN-SW02- positioning data. . . . .	76
67	MSP-C01- positioning data. . . . .	77
68	MSP-C02- positioning data. . . . .	78
69	MEI-C01- positioning data. . . . .	79
70	MEI-SW01- positioning data. . . . .	80
71	MEI-C02- positioning data. . . . .	81
72	MEI-SW02- positioning data. . . . .	82

## List of Tables

1	Acronyms of Organizations, Manufacturers and Products . . . . .	i
2	Cruise MARM09, operations at sea. Latitude, Longitude true position, Time UTC . . . . .	7
3	CTD and XBT positions, Time is UTC . . . . .	8
4	Scientific and technical parties . . . . .	9
5	Instrumental Offsets of PDS2000 <i>R/V Urania</i> . . . . .	11
6	Instrumental Offsets of Kongsberg's EM-710 <i>R/V Urania</i> . . . . .	11
7	OBS drop positions. Latitude, Longitude true position, Time UTC . . . . .	12
8	IFREMER's SERCEL LOTOBS technical specifications . . . . .	13
9	Piezometer bottom positions. Latitude, Longitude true position, Time UTC. Also shown associated Core,OBS and CHIRP file. . . . .	16
10	Detailed information of piezometer deployment. . . . .	17
11	INGV's SN-4 payload. . . . .	18
12	INGV's MEDUSA payload. . . . .	19
13	Bottom sample positions. Latitude, Longitude true position, Time UTC . . . . .	21
14	Core sample description. . . . .	32
15	Core MSN-C01. Subsampling table. . . . .	35
16	Core MSN-SW01. Subsampling table. . . . .	36
17	Extrusion of cores. Aliquots type, solvents, conservation. . . . .	36

# 1 INTRODUCTION AND BACKGROUNDS

After the 1999 disastrous Kocaeli earthquake the international community is attempting to produce reliable maps of active faults distribution in the Sea of Marmara. As a follow-up of this effort, within a framework of increasing knowledge of the North Anatolian Fault (NAF) system, a number of scientists is starting to realize that the Sea of Marmara constitute an unique opportunity to study seismogenic behavior of an active fault for several reasons, including the relatively high strain rates observed, and the presence of clear stratigraphic markers at the time scale of several thousand years. Another important point for studying the NAF system below the Sea of Marmara is that here the active fault segments lay close to a highly populated region and will be probably the site of large earthquakes in the next decades.

We believe that an integrated approach involving the acquisition and analysis of geophysical (multibeam, side-scan sonar, chirp), geological (cores) and seismological data, would represent an innovative strategy in the emerging field of submarine earthquake geology to assess the seismic hazard in the Marmara region. On the other hand, results from recent marine geological cruises that analysed the almost systematic association of cold seeps (emission of gas and fluids from the seafloor) and active faults in the Marmara Sea highlighted the importance of gathering long term time series to study correlation between fluid vents and seismicity. For this reason, the project includes a geological/geophysical survey in key areas of the Sea of Marmara as well as the deployment of a submarine observatory to monitor the behavior of the fault over a 1 year period.

Diverse earthquake scenarios can be envisioned that would fill the strain gap in the Sea of Marmara between the 1912 and 1999 ruptures, to the western and eastern bounds, respectively. The implications of each scenario for the hazard facing Istanbul (population: 12 million) and elsewhere around Marmara vary widely, and their likelihood needs to be evaluated. These evaluations can only be as reliable as the seismologic, geophysical and geological parameters on which they are based.

Major issues that can be addressed with reliable information on structure and rupture history are:

- 1 is the Marmara Sea gap going to be filled by a single large rupture or by a sequence of smaller ruptures?
- 2 is the plate motion through Marmara partitioned between distinct structures accommodating the trans-current and extensional components of motion?
- 3 do faults with complementary roles in such partitioned systems rupture in repeatable sequences?
- 4 how much close to rupture are seismogenic faults in the Marmara Sea as a result of the Coulomb stress effect of the 1999 sequence and what is the tsunamigenic potential of these structures?
- 5 are fluid and gas emissions observed during previous studies related to seismicity and could they be possibly used as earthquake precursors to mitigate hazards?

The survey carried out during MARMARA2009 combined multibeam, side-scan sonar maps and chirp sub-bottom profiles with carefully positioned core samples to resolve the shallow geometry and kinematics of portions of the fault system in the north eastern Marmara Sea.

Our purpose was to resolve fault geometry and kinematics and to date their most recent ruptures at the same scale as typical paleoseismological studies on land. We were guided by previous and ongoing projects studying larger scale and deeper characteristics of the fault array in the Marmara. Our strategy was to juxtapose morphology and structures along the inferred rupture of the 1999 İzmit earthquake with other faults that may have ruptured in previous historic earthquakes near Istanbul, such as the very large and destructive earthquakes centered in the eastern Marmara sea in 1509 and 1766. Particularly important was to identify features characteristic of submarine ruptures of transcurrent faults which may be subtle in reflection profiles.

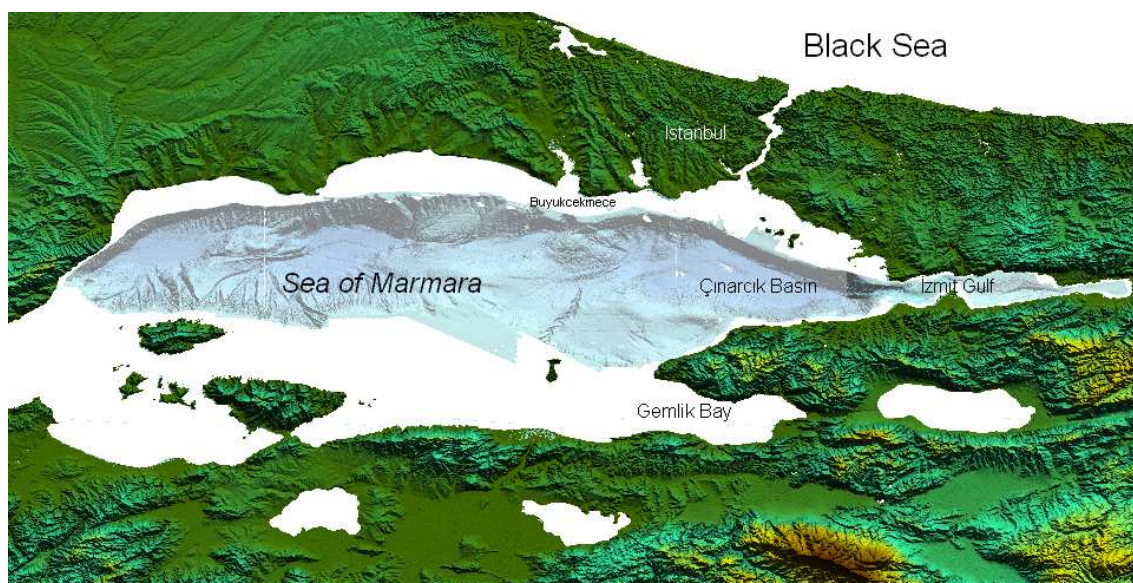

Figure 1: Sea of Marmara region setting. Bathymetry from Ifremer Atlas [Le Pichon et al.(2005)], DTM from SRTM data (Shuttle Radar Topogr. Mission NASA/ASI)

The main part of the cruise was however devoted to the deployment of submarine observatories (SN-4, OBS and piezometers) along the NAF track in the İzmitGulf (Fig.1 and 2), to collect a 1-year data series of seismicity and fluid emission from the seafloor and study possible correlations and possibly use them as earthquake precursors .

MARMARA2009 was carried out in the frame of MARMESONET project, a demo mission (DM) of the EC funded ESONET Network of Excellence (European Seafloor Observatory Network) that aims at demonstrating the relevance of Seafloor Observatories for monitoring geohazards in the Marmara Region. MARMESONET DM is complementary to KOERI's project MBSO (Marmara Sea Bottom Observatory project), which aims at implementing 5 cabled OBS in the Sea of Marmara, as part of the Turkish national network for earthquake and tsunami hazards monitoring. The MBSO project has an operational and research finality, while the MARMARA DM is research-oriented. The former aims at being integrated into the national Turkish seismic network. The latter aims at testing the hypothesis that the physical and geochemical properties of the fluids change within the fault throughout an earthquake cycle and that these changes can be recorded at the seafloor. If true, this hypothesis would open new perspectives to determine whether water and gas circulation in subsurface environments can generate detectable signals related to the stress-building process before large earthquakes, an issue of direct, social importance.

The collection of data series by bottom observatories was the main objective of the cruise. This implied a site survey prior deployment that included geophysical and geochemical observations carried out directly on board of Urania.

Specific tasks carried out during MARMARA2009 cruise were :

- 1 deploy 5 Piezometer and 10 OBS (Par.3.3, Par.3.2) at several locations in the Sea of Marmara, particularly close to active faults or fluid and gas emissions,
- 2 deploy the submarine observatory SN4 (Par.3.4), along the NAF track in the İzmitGulf
- 3 investigate with the MEDUSA towed observatory (Par.3.5), particularly by TV camera and methane sensor, some of the above areas
- 4 collect multibeam data from the Marmara shelves in depths ranging from 50 to 1000 m together with high-resolution 2D seismic lines
- 5 collect cores (gravity and water/sediment cores) at several sites in the Sea of Marmara



Main partners were : ITU(EMCOL) from Turkey, ISMAR and INGV from Italy and IFREMER and CNRS from France. At the international level, the project also benefits from the participation of scientists from the Scripps Institution of Oceanography (San Diego, California).

### Relevant previous or future research cruises

The present project is based on many previous research cruises carried out using R/V Odin Finder and R/V Urania and also on cruises of R/V Le Suroit and R/V L'Atalante within the framework of an Italy,France,USA and Turkey collaborative programme. The key areas have been identified through the interpretation of the previously collected geophysical and geological data along the NAF strands and cruise work was designed in order to map active structures and features likely useful to understand fault kinematics. For details about some of these cruises see:

- Odin Finder 2000, [projects.bo.cnr.it/CRUISE\\_REPORTS/2005/MARM05\\_REP](http://projects.bo.cnr.it/CRUISE_REPORTS/2005/MARM05_REP)
- Urania 2001, [projects.bo.cnr.it/CRUISE\\_REPORTS/2001/MARM2001\\_REP](http://projects.bo.cnr.it/CRUISE_REPORTS/2001/MARM2001_REP)
- Urania 2005, [projects.bo.cnr.it/CRUISE\\_REPORTS/2005/MARM05\\_REP](http://projects.bo.cnr.it/CRUISE_REPORTS/2005/MARM05_REP)

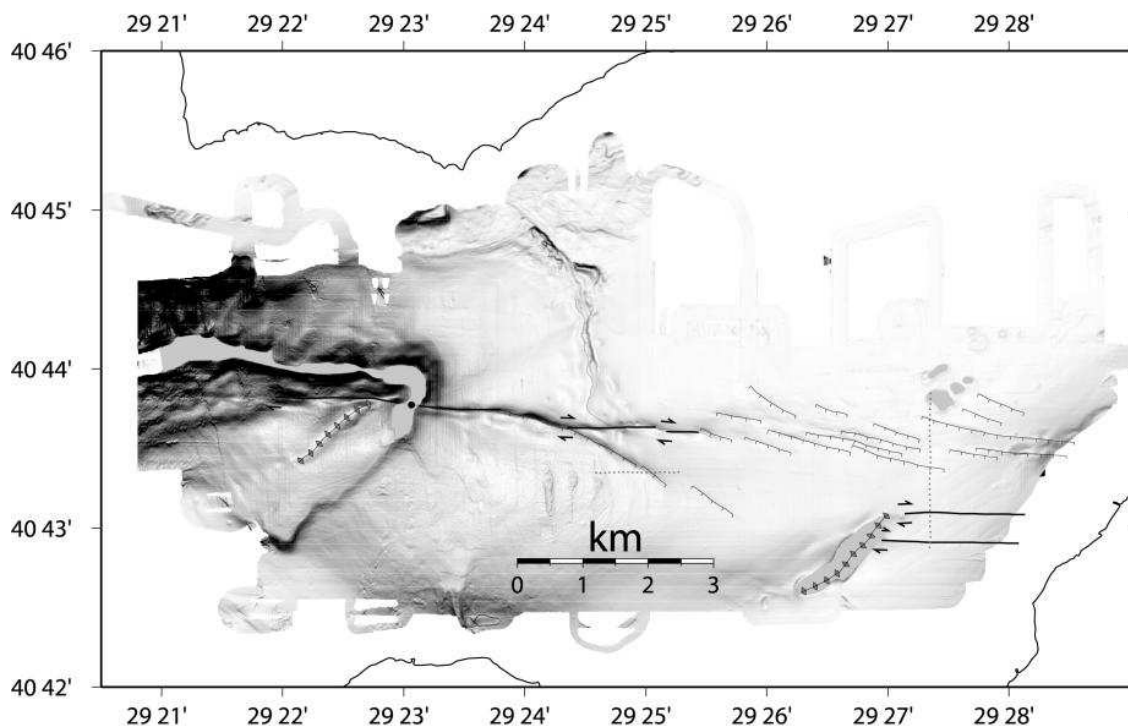

Figure 2: Morpho-tectonic map of the Darica basin close to the SN4 deployment site.

The references in bibliography cover broad aspects of the scientific problems and issues relating to the NAF in the Sea of Marmara, among the many others, tectonics, seismology, geochemical and sedimentary processes. Moreover, in recent years a lot of effort was also devoted to the study of cold seeps, gas and fluid emissions. [Geli et al. (2008)] presents the results of geophysical investigations and of submersible dives during cruises MARMARA (R/V Le Suroit, September 2000) and MARNAUT (R/V L'Atalante, May-June 2007), pointing to clearcut evidence of gas and fluid emissions and active tectonics in the Sea of Marmara, particularly in the Çınarcık Basin. [Cagatay et al.(2009)] discusses the late Pleistocene-Holocene stratigraphy of the northern shelf of the Sea of Marmara extending back to isotope stage 6. This study reports the discovery of two new sapropel units deposited during isotope stage 5 highstand and discusses water exchange between the Black Sea and Mediterranean through the Sea of Marmara during various isotopic stages, based on seismic stratigraphic and core analyses.

## 2 CRUISE SUMMARY

SHIP: *R/V Urania* Flag: Italy [IT] Call Sign: IQSU IMO: 9013220, MMSI: 247498000 START: 2009-09-22 PORT: Brindisi

END: 2009-10-12 PORT: Messina

SEA/OCEAN: Sea of Marmara, Mediterranean Sea

LIMITS: NORTH 40:00.0 SOUTH: 41:15.0 WEST: 25:30.0 EAST: 30:00

OBJECTIVE: Active Faults and historical earthquakes in the Marmara Sea

COORDINATING BODIES: ISMAR-Bologna BOLOGNA (ITALY)

CHIEF OF EXPEDITION: Luca Gasperini (ISMAR-CNR)

CONTACT: Luca.Gasperini@ismar.cnr.it

DISCIPLINES: MARINE GEOLOGY, MARINE GEOPHYSICS, PHYSICAL OCEANOGRAPHY, CHEMICAL OCEANOGRAPHY, BOTTOM OBSERVATORIES

WORK DONE: SN4, 10 OBS, 5 PIEZOMETERS DEPLOYMENT, MEDUSA INVESTIGATIONS 850 KM<sup>2</sup> MULTIBEAM, 1650 KM SBP

11 GRAVITY CORES , 4 SW CORES, 15 CTD CASTS, 18 XBT,

LOCALIZATION:

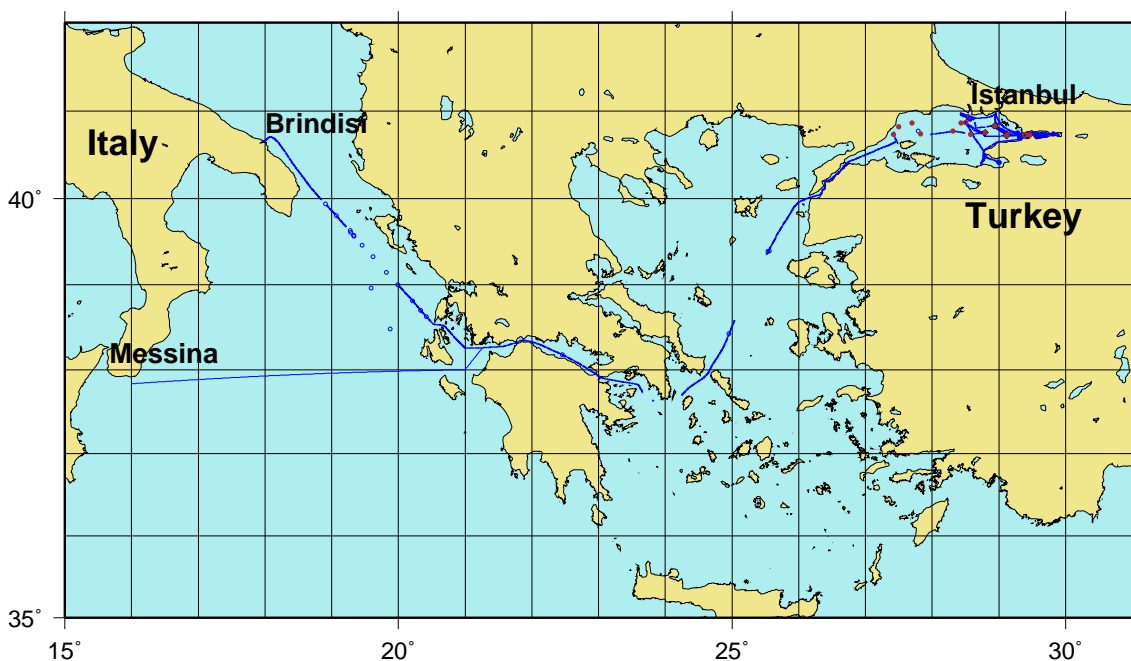

Figure 3: General ship track during Cruise MARM09, including transits from Brindisi and to Messina. Circles with small circle are OBS, rhombs with circle are piezometers, hollows are CTD stations.

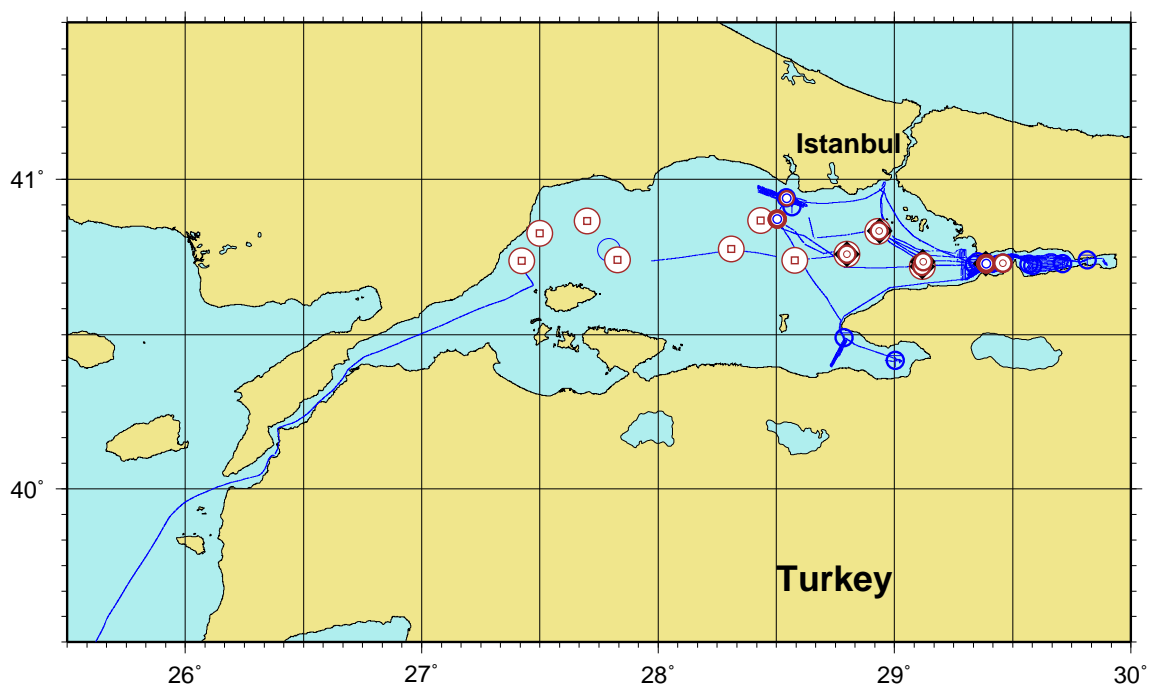

Figure 4: Ship track during Cruise MARM09 in the Marmara Sea. Circles with small circle are OBS, rhombs with circle are piezometers, hollows are CTD stations.

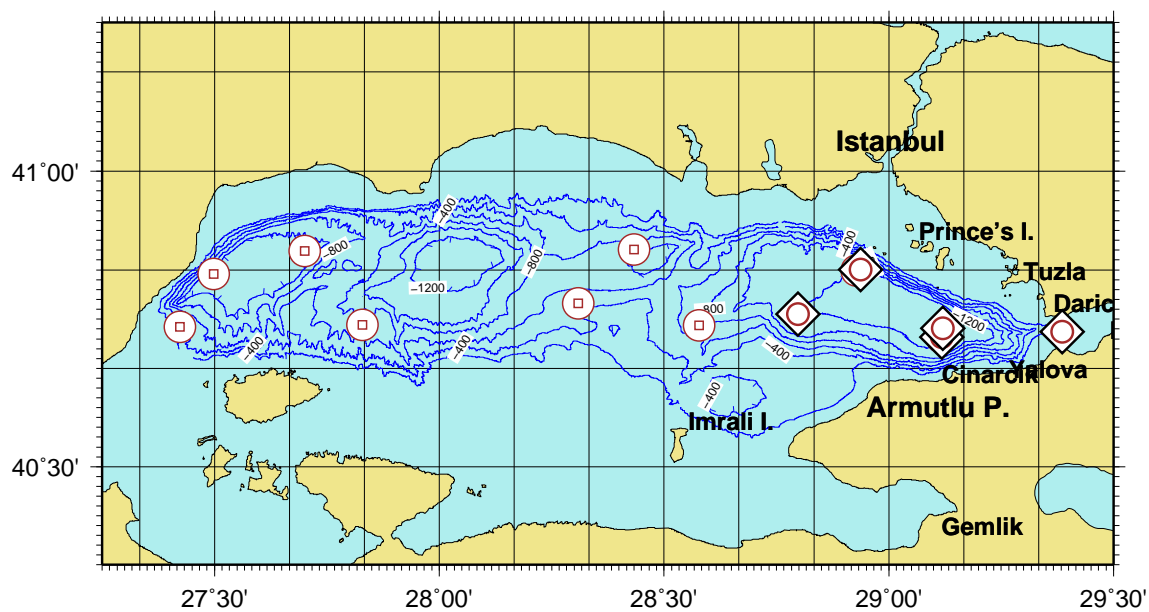

Figure 5: Deployment sites of piezometers and OBS..



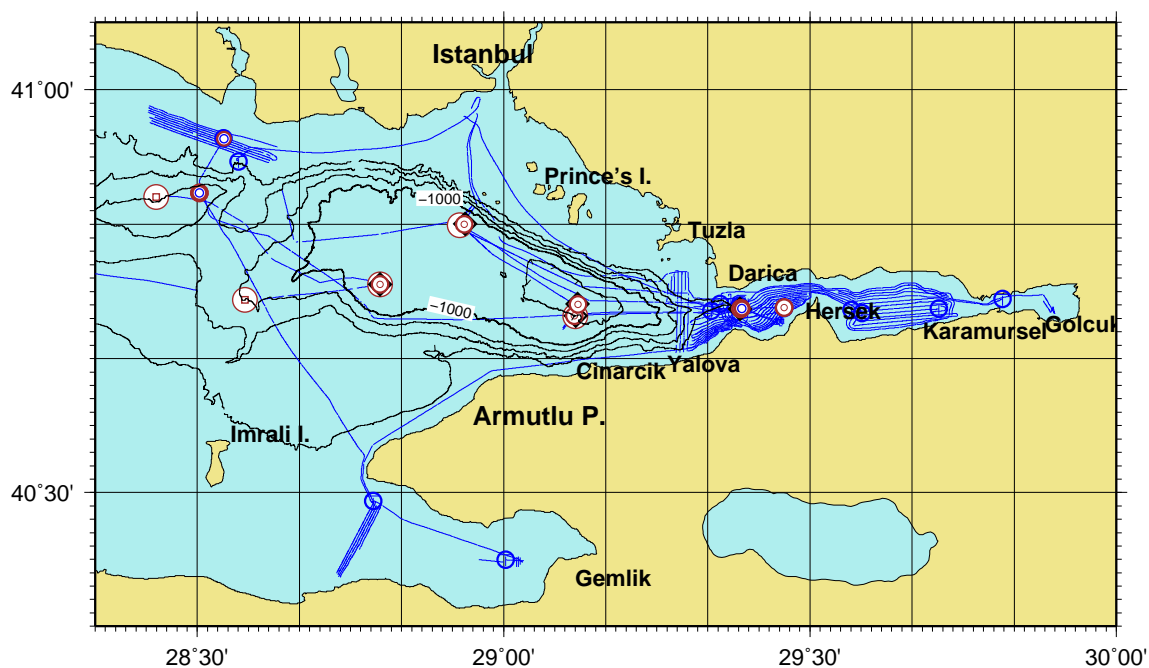

Figure 6: Navigation in Çınarcık and İzmit regions. Circles with small circle are OBS, rhombs with circle are piezometers, hollows are CTD stations.

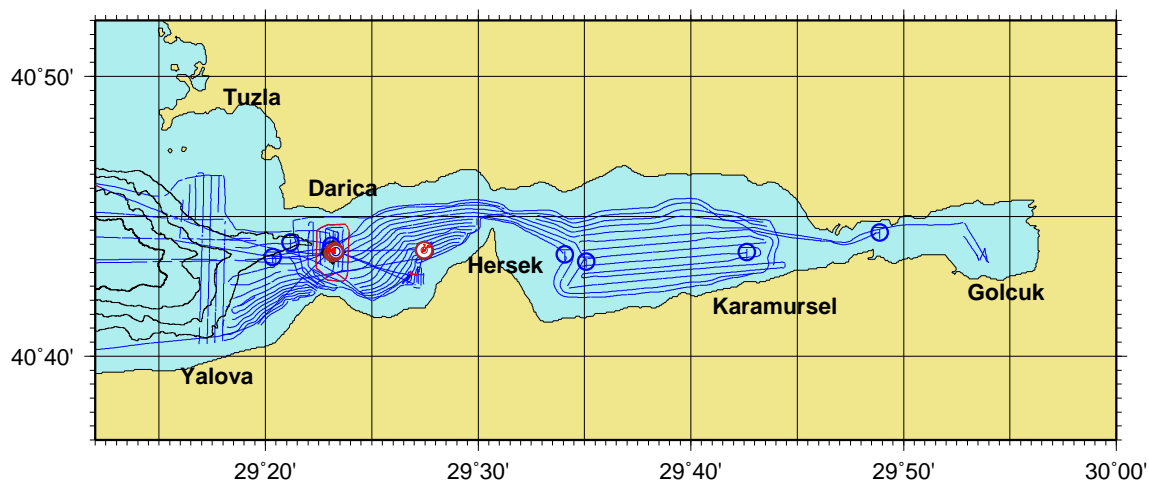

Figure 7: Navigation in İzmit regions. Circles with small circle are OBS, rhombs with circle are piezometers, hollows are CTD stations.

LAT LON(TRUE) UTM35(TRUE)	LAT LON HDG(SHIP)	TIME(UTC)	OPERATION
2725.3936 4044.2150 535735 4509639	2725.3912 4044.2229 16.7	2009-09-27T03:06:04	OBS01-LV03-
2729.9079 4049.5494 542032 4519542	2729.9070 4049.5575 24.7	2009-09-27T04:45:42	OBS02-LV11-
2742.0275 4051.8859 559030 4523981	2742.0366 4051.8902 87.7	2009-09-27T06:16:09	OBS03-LV02-
2749.7209 4044.4076 569967 4510240	2749.7307 4044.4044 142.7	2009-09-27T07:19:41	OBS04-LV07-
2818.5332 4046.5612 610453 4514718	2818.5389 4046.5680 62.4	2009-09-27T09:48:00	OBS05-LV12-
2834.6671 4044.3661 633218 4511030	2834.6762 4044.3619 151.4	2009-09-27T11:18:06	OBS06-LV09-
2847.8815 4045.5070 651771 4513498	2847.8816 4045.5120 45.3	2009-09-27T13:18:01	MPZ-01-
2847.8665 4045.5046 651750 4513493	2847.8869 4045.5140 60.5	2009-09-27T15:36:01	PZ-A-
2847.8779 4045.5176 651766 4513518	2847.8880 4045.5150 137.7	2009-09-27T17:19:18	OBS07-LV05-
2825.9607 4052.0406 620734 4525019	2825.9501 4052.0416 307.0	2009-09-27T20:03:59	OBS08-LV08-
2907.0277 4043.1575 678813 4509752	2907.0515 4043.1583 89.4	2009-09-28T08:39:32	PZ-B-
2906.9286 4043.1818 678673 4509794	2906.9336 4043.1851 93.6	2009-09-28T11:09:21	MPZ-02-
2907.0253 4043.1647 678809 4509765	2907.0352 4043.1676 97.9	2009-09-28T11:54:17	OBS09-LV10-
2907.2033 4044.0456 679021 4511401	2907.2270 4044.0433 99.1	2009-09-28T13:05:47	PZ-C-
2907.2564 4044.0267 679096 4511368	2907.2597 4044.0311 74.9	2009-09-28T14:30:23	MPZ-03-
2855.6879 4049.9109 662575 4521880	2855.6950 4049.9169 71.4	2009-09-28T17:33:18	OBS10-LV01-
2923.1766 4043.6859 701521 4511313	2923.1701 4043.6867 324.5	2009-09-29T06:19:45	MPZ-04-
2923.1742 4043.6853 701517 4511312	2923.1539 4043.6948 303.4	2009-09-29T07:48:34	PZ-D-
2856.2232 4050.0033 663323 4522067	2856.2044 4050.0145 309.6	2009-09-29T12:48:18	PZ-E-
2856.1343 4049.9861 663199 4522033	2856.1283 4049.9882 339.9	2009-09-29T14:04:03	MPZ-05-
2923.0715 4043.7790 701368 4511481	2923.0483 4043.7749 258.4	2009-10-03T06:22:15	MSN-BC01-
2923.0737 4043.7880 701371 4511498	2923.0974 4043.7860 98.3	2009-10-03T07:02:42	MSN-BC02-
2923.2642 4043.7372 701641 4511411	2923.2610 4043.7416 15.7	2009-10-03T08:57:43	MSN-C01-
2923.2519 4043.7479 701624 4511431	2923.2453 4043.7470 305.0	2009-10-03T10:13:11	MSN-C02-
2923.2456 4043.7445 701615 4511424	2923.2441 4043.7396 237.6	2009-10-03T11:28:35	MSN-C03-
2923.2393 4043.7452 701606 4511425	2923.2211 4043.7569 312.0	2009-10-04T15:56:16	SN4-
2923.2410 4043.7433 701609 4511422	2923.2254 4043.7571 321.1	2009-10-04T16:14:17	SN4-RELEASE
2923.2990 4043.7636 701689 4511462	2923.3224 4043.7601 102.8	2009-10-04T18:46:00	SN4-RESPONSE
2923.2356 4043.7429 701601 4511421	2923.2366 4043.7380 216.2	2009-10-05T06:56:21	SN4-FM-MEDUSA
2923.3125 4043.7381 701709 4511415	2923.3180 4043.7409 101.2	2009-10-06T08:01:09	MSN-SW01-
2923.3166 4043.7361 701715 4511411	2923.3218 4043.7392 97.1	2009-10-06T08:44:05	MSN-SW02-
2927.4719 4043.7841 707562 4511662	2927.4744 4043.7794 202.6	2009-10-06T10:08:18	MSP-C01-
2927.4790 4043.7832 707572 4511660	2927.4729 4043.7812 291.6	2009-10-06T11:47:57	MSP-C02-
2830.2163 4052.2810 626703 4525564	2830.2144 4052.2858 28.5	2009-10-07T12:22:24	MEI-C01-
2830.2213 4052.2798 626710 4525562	2830.2181 4052.2842 16.3	2009-10-07T12:55:30	MEI-SW01-
2830.2238 4052.2782 626714 4525559	2830.2228 4052.2831 36.1	2009-10-07T13:39:20	MEI-C02-
2832.5955 4056.3491 629912 4533149	2832.5939 4056.3540 31.2	2009-10-07T14:53:04	MEI-SW02-

Table 2: Cruise MARM09, operations at sea. Latitude, Longitude true position, Time UTC

LON	LAT	DATE_TIME	STATION
1854.29	3956.57	2009-09-23T15:55:05	XBT-01069417
1904.22	3948.19	2009-09-23T16:59:43	XBT-01069417
1916.78	3937.81	2009-09-23T18:17:20	XBT-01069406
1917.24	3936.78	2009-09-23T18:25:06	XBT-00000000
1919.46	3934.79	2009-09-23T18:39:58	XBT-00000000
1920.19	3934.14	2009-09-23T18:44:48	XBT-00000000
1927.58	3927.69	2009-09-23T19:33:34	XBT-01069421
1937.30	3919.74	2009-09-23T20:39:32	XBT-01069422
1949.14	3908.75	2009-09-23T22:00:12	XBT-01069416
1959.53	3900.15	2009-09-23T23:10:02	XBT-01069418
2012.90	3848.75	2009-09-24T00:39:47	XBT-01069425
2020.14	3841.88	2009-09-24T01:32:31	XBT-01069423
2025.19	3837.60	2009-09-24T02:06:40	XBT-01069410
2227.36	3810.70	2009-09-24T12:26:14	XBT-01069414
2457.39	3825.41	2009-09-25T03:46:47	XBT-00000000
2532.48	3923.23	2009-09-25T09:41:42	XBT-01069419
2735.56	4052.43	2009-09-27T05:35:57	XBT-01069758
2747.57	4046.37	2009-09-27T07:00:56	XBT-01069411
2533.64	3923.68	2009-10-09T13:21:42	XBT-01069407
2452.40	3816.52	2009-10-09T19:52:09	XBT-01069403
2233.85	3808.36	2009-10-10T08:46:18	XBT-01069754
2023.43	3759.13	2009-10-10T18:33:53	XBT-01069908
2004.11	3758.50	2009-10-10T19:53:25	XBT-01069741
1943.23	3758.34	2009-10-10T21:18:34	XBT-01069909
1826.13	3757.22	2009-10-11T02:37:19	XBT-01069916
1748.20	3756.54	2009-10-11T05:19:30	XBT-01069913
1728.82	3755.91	2009-10-11T06:44:56	XBT-01069745
1703.73	3754.99	2009-10-11T08:29:26	XBT-01069743
1639.46	3754.35	2009-10-11T10:16:03	XBT-01069749
1611.63	3753.49	2009-10-11T12:15:09	XBT-01069749
1537.16	3805.79	2009-10-11T15:19:23	XBT-01069742
1537.16	3805.79	2009-10-11T15:19:23	XBT-01069742
2907.06	4043.16	2009-09-28T05:44:14	CTD_04
2855.70	4049.90	2009-09-28T17:07:54	CTD_05
2921.18	4044.07	2009-09-29T05:11:25	CTD_06
2834.02	4054.67	2009-09-29T17:53:33	CTD_07
2923.10	4043.95	2009-09-01T05:21:57	CTD_08
2935.08	4043.38	2009-09-01T19:02:30	CTD_09
2942.63	4043.72	2009-09-01T20:28:13	CTD_10
2948.87	4044.43	2009-09-02T06:04:08	CTD_11
2923.05	4043.77	2009-09-03T05:41:37	CTD_12
2923.23	4043.74	2009-09-04T10:48:40	CTD_13
2920.34	4043.55	2009-09-04T19:50:30	CTD_14
2927.48	4043.78	2009-09-05T22:21:22	CTD_15
2934.07	4043.64	2009-09-06T13:17:35	CTD_16
2847.21	4029.38	2009-09-06T22:37:07	CTD_17
2900.21	4024.98	2009-09-07T05:44:13	CTD_18
2832.57	4056.38	2009-09-07T15:12:41	CTD_19

Table 3: CTD and XBT positions, Time is UTC

## SCIENTIFIC AND TECHNICAL PARTIES

PARTICIPANTS	ORGANIZATION	EXPERTISE	tel & email & www
Luca Gasperini	ISMAR	Chief Scientist	L.Gasperini@ismar.cnr.it
Giovanni Bortoluzzi	ISMAR		G.Bortoluzzi@ismar.cnr.it
Fabrizio Del Bianco	ISMAR		f.delbianco@bo.ismar.cnr.it
Ercan Engin Kuruoglu	ISTI		ercankuruoglu@googlemail.com
Stefania Romano	ISMAR		s.romano@bo.ismar.cnr.it
Paolo Favali	INGV		paolofa@ingv.it
Giuditta Marinaro	INGV		giuditta.marinaro@ingv.it
Luigi Innocenzi	INGV		innocenzi@ingv.it
Giuseppe Etiope	INGV		etiope@ingv.it
Flavio Furlan	TECNOMARE		flavio.furlan@tecnomare.it
Luis Geli	IFREMER		l.geli@ifremer.fr
Pascal Pelleau	IFREMER		p.pelleau@ifremer.fr
Ronan Apprioual	IFREMER		r.apprioual@ifremer.fr
David Le Piver	IFREMER		d.lepiver@ifremer.fr
Mickael Roudaut	IFREMER		m.roudaut@ifremer.fr
Namık Çağatay	ITU-EMCOL		cagatay@itu.edu.tr
Naci Görür	ITU-EMCOL		naci@stokist.com
Remzi Akkök	ITU-EMCOL		akkok@itu.edu.tr
Sinan Özeren	ITU-EMCOL		ozere@s@itu.edu.tr
Emine Akarsu	MTA		akarsu@mta.gov.tr
Aslı Zeynep Can	MTA		can@mta.gov.tr
Şebnem Elbek	COMU		selbek@comu.edu.tr
Ümmühan Saadet Sancar	ITU-EMCOL		sancarum@itu.edu.tr
Demet Biltekin	ITU-EMCOL		biltekin@itu.edu.tr
Aslı Özmaral	ITU		
Umut Barış Ülgen	ITU-EMCOL		ulgenum@itu.edu.tr
Dursun Acar	ITU-EMCOL		dursunacaracar@hotmail.com
Laura Cefalogli	UNIBO		laura.cefalogli@studio.unibo.it
Vittoria Venditti	UNIBO		vittoria.venditti@studio.unibo.it

Table 4: Scientific and technical parties

### 3 MATERIALS AND METHODS

The research cruise was carried out with the 61 meter *R/V Urania* (Fig.8), owned and operated by SO.PRO.MAR. and on long-term lease to CNR. The ship is normally used for geological, geophysical and oceanographical work in the Mediterranean Sea and adjoining waters, including but not limited to, the Atlantic Ocean, the Red Sea, and the Black Sea.

*R/V Urania* is equipped with DGPS and SEAPATH positioning system (satellite link by FUGRO), single-beam and multibeam bathymetry and integrated geophysical and oceanographical data acquisition systems, including ADCP, CHIRP SBP and other Sonar Equipment, other than water and sediment sampling. Additional equipment can be accommodated on the keel or towed.



Figure 8: *R/V Urania*.

#### 3.1 NAVIGATION AND DATA ACQUISITION

The vessel was set-up for data acquisition and navigation with PDS-2000 software by RESON, interfacing by a multiseriial and Ethernet link several instruments, among them the DGPS (Fugro), the Atlas-Krupp Deso-25 single-beam echosounder, the MAHRS MRU and the meteorological station. The position and depth data were also distributed to the CTD data acquisition console. A Kongsberg processor running the SIS software, collected the multibeam data, including a SEAPATH MRU, compass, and DGPS. The MBES was the 70kHz, 400 1x2°, 150° aperture EM-710 (2000 m range) model by Kongsberg, with sonar head positioned on the ship's keel using a V-shaped steel frame. A Sound Velocity probe at the keel 1m above the Sonar Head is interfaced directly to the MBES processor, thus providing the necessary real-time data for the beam-forming. CTD casts were used for input of the sound velocity profile to the system. An Anderaa Meteorological Station was also made available, at a rate of one measurement every 5 minutes.

POSITION	ACROSS	ALONG	HEIGHT
REFERENCE POINT	0.00	0.00	0.00
DGPS	1.64	14.30	14.18
MBEAM	0.00	14.36	-4.96
MAHRS	0.00	0.0	-3.40
ECHO SOUNDER 33	5.50	-1.85	-3.80
CHIRP	-1.0	11.80	-4.00
A-FRAME	6.5	-6.70	0.0
STERN	0.00	-30.60	0.00

Table 5: Instrumental Offsets of PDS2000 on Ship Urania (PDS2000). The GPS antenna (primary positioning system) is located on point DGPS.

POSITION	ACROSS	ALONG	HEIGHT
REFERENCE POINT	0.00	0.00	0.00
SEAPATH_GPS	-4.039	0.163	-18.211
MRU	-0.341	-1.342	-1.596
MBEAM_TX	0.0936	10.2964	5.0623
MBEAM_RX	-0.0031	11.0144	5.0600
SEALEVEL	0	0	-0.0875

Table 6: Instrumental Offsets on Ship Urania (EM710). The DGPS antenna (primary positioning system) is located on point SEAPATH\_GPS.

## CTD DATA

CTD casts were taken throughout the surveyed areas, for sound velocity analysis, and were used for real-time MBES acquisition and post-processing. On the way from and to Italy, several Deep Blue XBT launches data were collected by a Sippican Mod. MK21 profiler.

The position of the XBT and CTD stations are reported in Table 3 and can be viewed in Fig.3 and Fig.4, respectively.

## CHIRP SBP

SBP data was acquired by the 16 transducers, hull mounted BENTHOS (DATASONICS) Mod.CAP-6600 CHIRP-II profiler, with operating frequencies ranging between 2 and 7 kHz. The pulse length was maintained at 20 ms while the trigger rates varied from 0.25 to 1 seconds according to water depth. Digital data acquired by the Communication Technology SWANPRO software were recorded in the XTF format on local disks and transferred on the network upon request. Backups were loaded on HD and DVD. The navigation data was made available to the system as lat/long by NMEA sentences of the DGPS receiver at a rate of approximately 1 Hz or by the PDS200's NMEA at 1Hz. The XTF data were then converted to SEG-Y by the Triton-Elics's Xtf2Seg software. This latter data were then input to the ISMAR's SEISPRO software [Gasperini and Stanghellini(2009)] for data processing and display. Since the SEG-Y converted positions were found to be truncated, the accurate position data were recovered from the XTF headers by routines developed at ISMAR, and re-input to SEISPRO. The operation was also useful to check data integrity, other than for producing the navigation map and database.



### 3.2 OBS

A number of 10 LotOBS Sercel OBS (designed by IFREMER, Fig.9), were deployed. Tabs.7 and Fig.5) show positioning data, and technical specifications are reported in Tab.8). LotOBS is specialised for seismological data acquisition, uses the same acquisition electronics as in the previously developed MicroOBS. In order to include sufficient batteries to be able to record for 8 months (during a deployment period of up to 12 months) the instrument is housed in a 17 inch glass sphere with a weight in air of about 50 kg. The external 4.5 Hz geophones are deployed briefly after the arrival of the instrument on the sea-floor.

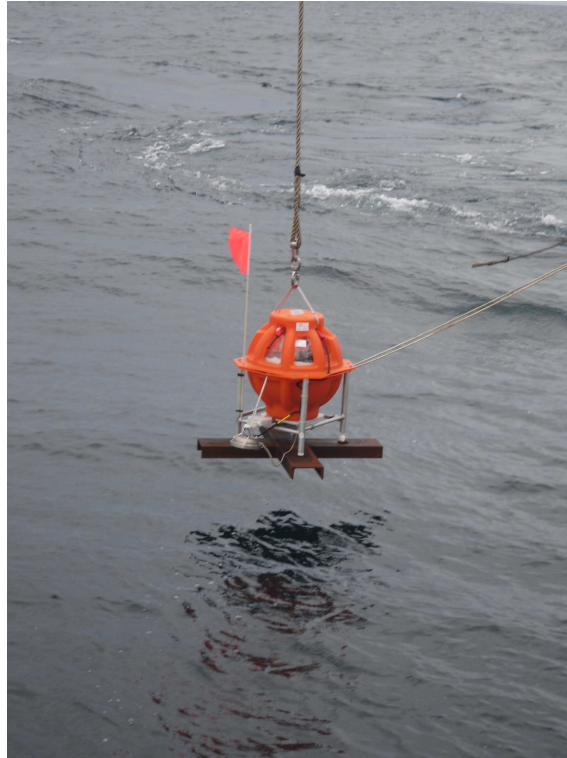

Figure 9: OBS at launch.

LON LAT	DATE.TIME	OBS	NOTES
2725.3936 4044.2150	2009-09-27T03:06:04	OBS01	S/N-LV03 0x094 F73 F71
2729.9079 4049.5494	2009-09-27T04:45:42	OBS02	S/N-LV11 0x09C F83 F81
2742.0275 4051.8859	2009-09-27T06:16:09	OBS03	S/N-LV02 0x093 F70 F6E
2749.7209 4044.4076	2009-09-27T07:19:41	OBS04	S/N-LV07 0x098 F7B F79
2818.5332 4046.5612	2009-09-27T09:48:00	OBS05	S/N-LV12 0x09D F84 F82
2834.6671 4044.3661	2009-09-27T11:18:06	OBS06	S/N-LV09 0x09A F7F F7D
2847.8779 4045.5176	2009-09-27T17:19:18	OBS07	S/N-LV05 0x096 F77 F75
2825.9607 4052.0406	2009-09-27T20:03:59	OBS08	S/N-LV08 0x099 F7C F7A
2907.0253 4043.1647	2009-09-28T11:54:17	OBS09	S/N-LV10 0x09B F80 F7E
2855.6879 4049.9109	2009-09-28T17:33:18	OBS10	S/M-LV01 0x092 F6F F6D

Table 7: OBS drop positions. Latitude, Longitude true position, Time UTC

General	Profondeur maxi. Poids dans l'air Poids dans l'air avec lest Poids dans l'eau Poids dans l'eau avec lest Dimensions (H / L / I)	5000 m 50 kg 75 kg -8 kg 17 kg L 550 x l 550 x H 700 mm
Capteurs	4 composantes Sensibilité hydro Hydrophone LF-3dB Hydrophone signal pleine échelle Géophones Type géophones Géophone sensibility Géophone pleine échelle Orientation	1 hydro et 3 geophones - 160 dB ref. 1 mV/microPa 2 Hz 70 Pa 3 axes 4,5 Hz (-3 dB) 22,4 mV/mm.s-1 +/- 0,38 mm.s-1 Compas 3 axes
Acquisition	Canaux sismiques Résolution Fréquence d'échantillonnage Bande de mesure Gain du préamplificateur Horloge Correction de dérive d'horloge Interface de synchronisation Stockage Interface de configuration	4 24 bits 25 250 Hz DC to 0,40 x f echantillonnage Variable de 1 64 3.10-7 (0,3 ppm) ou 5.10 <sup>-8</sup> Correction lineaire de la derive DCF 77 (signal GPS) 32 Go (disque IDE SSD) RS232 (9 600, 1, 1)
Energy	Pack pile alcaline ou lithium Consommation électrique Autonomie	Pile Li-lon 0,7 W recording, 0,3 W low power de 1 12 mois
Localisation Flash Gonio VHF	Novatech (ST 400-A) Novatech RF700A-1VHF 156,625 MHz	

Table 8: IFREMER's SERCEL LOTOBS technical specifications.

### 3.3 PIEZOMETERS

The IFREMER piezometer (V2) is a device to measure the differential pressure and temperature at different levels in the sediment, for long term duration periods, after wich system is recovered at surface by acoustic release. Its applications are relative to geohazards including slope stability and relations between seismicity and fluids. The deployment duration can be up to 2 years (batteries and memory). The system is deployed on the bottom by the ship in station, and released upon satisfactory check of its attitude, principally verticality, to assure proper functioning during the mission. The pipe and data logger head are handled and prepared for launch by a lodging device transported over a frame firmly secured to the ship stern's deck by steel angular, plates, T frames (See Fig.12, 13 and 14).

Its main specifications are:

- Up to 15 sensors, up to 15 m length
- water proofness of electronic and sensor (PBOF) up to 6000m
- Clock synchronisation (PPS input and DCF emulation input)
- pressure range  $\pm 2000$  mbar, accuracy: 0.2%, resolution 1 mbar
- Temperature range 0-40 °C, accuracy 0 to  $+25^{\circ}\text{C} \pm 0.05^{\circ}\text{C}$ , resolution 0 to  $25^{\circ}\text{C} < 0.015^{\circ}\text{C}$  at  $10^{\circ}\text{C}$ .



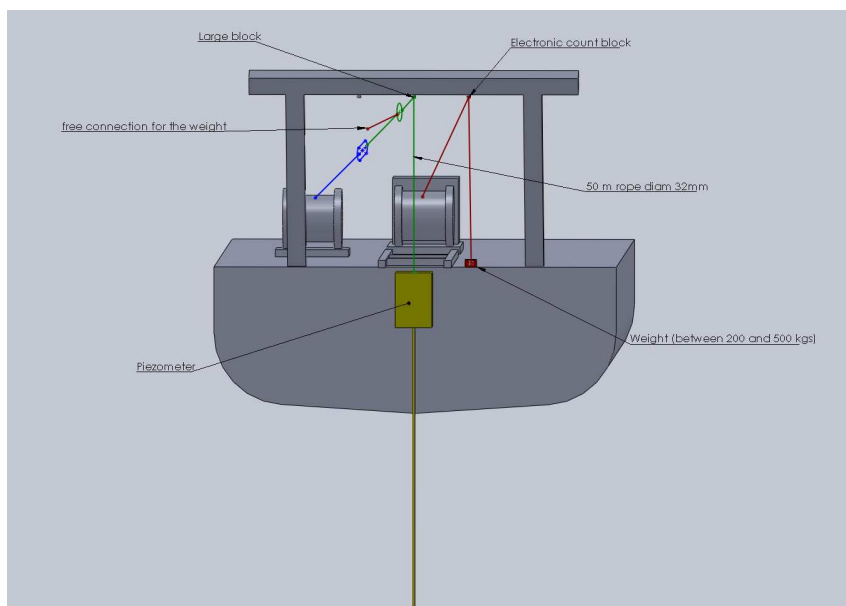

Figure 10: Sketch of the Piezometer deployment.

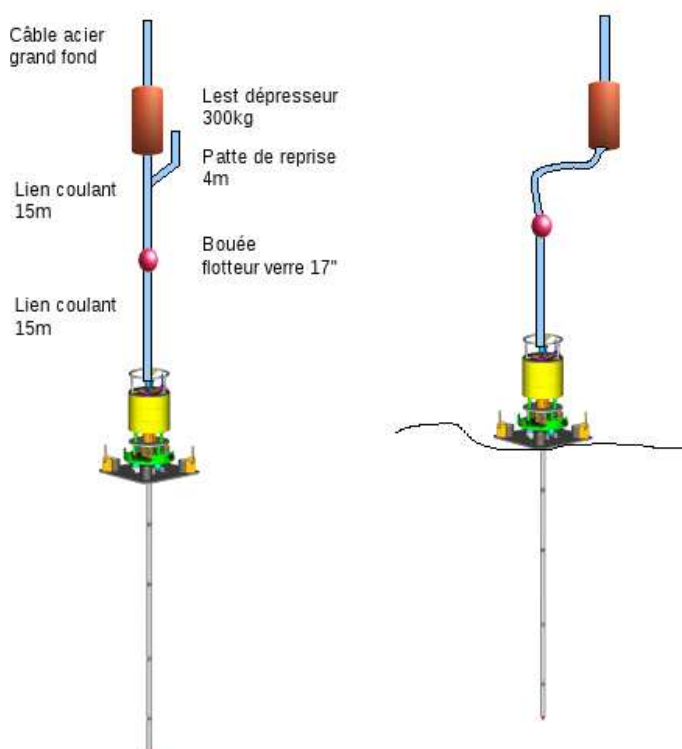

Figure 11: Sketch of the Piezometer deployment.

After installation of launch system on the deck of the *R/V Urania*, the piezometer deployment was firstly tested when ship was docked at Çannakale 2009-10-26. The operations on deck were performed by using the ship's main winch for the deployment and the SideScanSonar lateral winch laying Dynema and polyester ropes for the handling of the dead weight and buoy, as it is shown in the sketches of Fig.10 and 11. The final set-up was achieved by slight adjustments of the

supporting frame on deck and of cable lengths from the auxiliary and main winch. The deployment of piezometers took place from 2009-09-27 up to 2009-09-30. After final checks of the selected sites by multibeam and CHIRP investigations, ship was put in station and the piezometer was : (a) put at 30-50m above the seafloor for 10 minutes for stabilization, (b) deposited on the seafloor, (c) decoupled from ship by delivering 30m of cable and (d) released after interrogation by acoustic modem with acceptable response on instrument's attitude and proper functioning. Table 10 gives detailed information on the whole operation.

Five Piezometers were deployed in the ÇınarcıkBasin and near the SN4 site. Tab.9 and Fig.5 show the positioning data

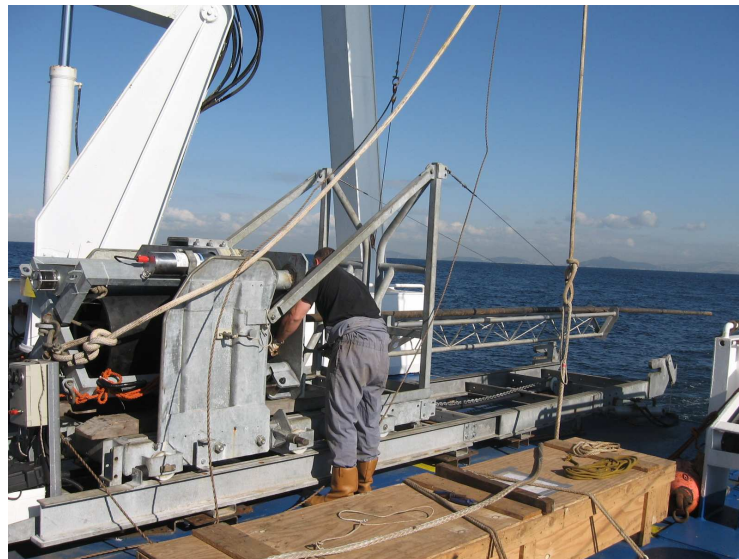

Figure 12: Piezometer being prepared on the launch frame.

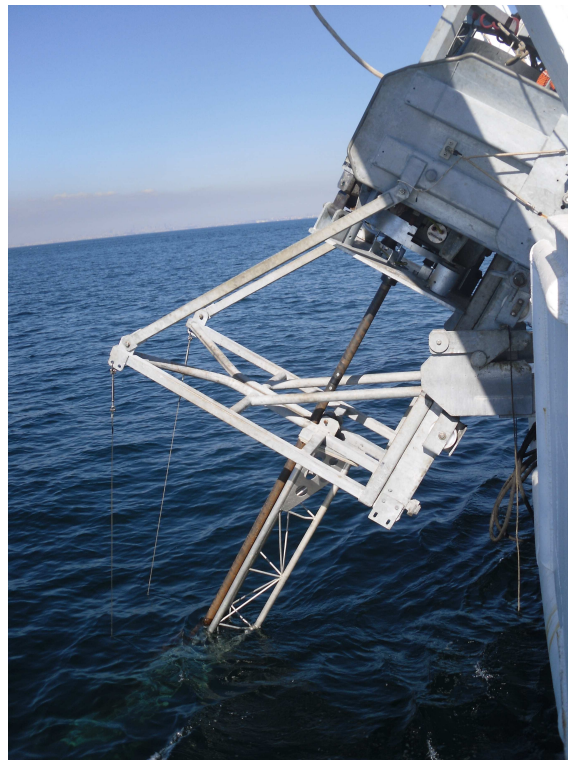

Figure 13: Piezometer being put vertical for launch by the oleopneumatic pistons.

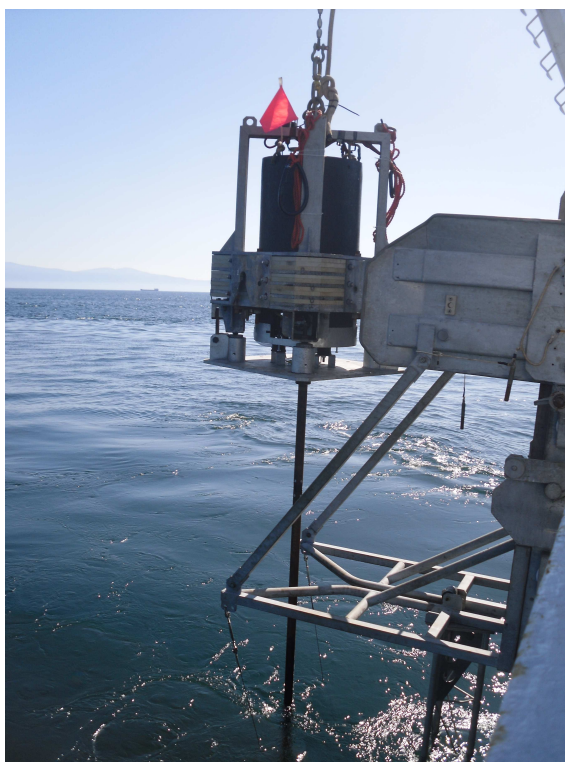

Figure 14: Piezometer ready for launch.

LON LAT	DATE_TIME	PIEZO	CORE	OBS	CHIRP	NOTES
2847.8665 4045.5046	2009-09-27T15:36:01	PZ-A	MPZ-01	OBS07	MA09-066(842)	S/N-01 1693 1649 1655
2907.0277 4043.1575	2009-09-28T08:39:32	PZ-B	MPZ-02	OBS09	MA09-103(2040)	S/N-02 1691 1649 1655
2907.2033 4044.0456	2009-09-28T13:05:47	PZ-C	MPZ-03	OBS09	MA09-112(2110)	S/N-03 1692 1649 1655
2923.1742 4043.6853	2009-09-29T07:48:34	PZ-D	MPZ-04	SN4	MA09-177(350)	S/N-05 1695 1649 1655
2856.2232 4050.0033	2009-09-29T12:48:18	PZ-E	MPZ-05	OBS10	MA09-188(760)	S/N-04 1690 1649 1655

Table 9: Piezometer bottom positions. Latitude, Longitude true position, Time UTC. Also shown associated Core,OBS and CHIRP file.

Heure	Operation
10h30	Début de l'opération de mise à l'eau, le câble acier grand fond est dans l'axe, la laisse piézomètre est sur le treuil de manœuvre. Débordement du chariot, piézomètre lie au câble grand fond, et au treuil de manœuvre. Mise à l'eau du piézomètre sur le câble grand fond dans l'axe du bateau, après immersion du piézomètre, palier de 5 minutes pour remplissage. Basculement du poids du piézomètre sur le câble de manœuvre ( coté bâbord), le piézomètre quitte l'axe du bateau. Il peut être utile d'assurer le passage sur bâbord avec un cordage supplémentaire que l'on manœuvrera sur le cabestan. On remonte le chariot de mise à l'eau (le train). On remonte le piézo par le ceble de manœuvre, pour libérer le câble grand fond.
10h50	Filage du piézomètre sur le câble de manœuvre, à mis parcours mise en place du flotteur, puis filage du reste de la laisse jusqu'au niveau du tableau arrière du bateau. Sur le câble principal mise en place du lest dépresseur. Changement de main, on repasse le poids du piézomètre sur le câble principal grace à la patte d'oie en haut de la laisse. Le piézomètre repasse dans l'axe du câble grand fond.
11h05	Le filage peut commencer Le filage s'effectue à une vitesse de 1 m/s, le treuil grand fond fourni une information sur la longueur filée que l'on utilise pour le palier fond. La précision de cette information est trs relative. On arrête le filage 100 m avant le fond pour un palier de 10 minutes. Le piézo est alors a 50m du fond.
11h35	Reprise du filage pour enfoncement. Surveiller de très prêt le poids sur le câble pour bien déterminer le moment de l'enfoncement de la pointe, filer 10m de plus.
11h50	Vérifier l'horizontalité du largueur acoustique du lest (038C + 0349), puis larguer le lest (038C+0355).Décoller le lest du fond, comme la mer est calme la vitesse du treuil est entre 0,2 et 0,5 m/s. Remonté du lest à la vitesse max du treuil : 1,5m/s.
12h10	Il faut à nouveau faire un changement de main, on peut utiliser la grue pour sortir le lest de l'eau et le positionner à la verticale sur le pont sur l'électronique du piézo suivant.

Table 10: Detailed information of piezometer deployment.

### 3.4 SN4 BOTTOM OBSERVATORY

The INGV and TECNOMARE SN-4 observatory was developed in the framework of ORION (Ocean Research by Integrated Observatory Networks) EC project and deployed as node of ASSEM (Array of Sensors for long-term SEabed Monitoring of geohazards) EC project during a joint experiment in the Corinth Gulf (Greece, 400 m w.d.) in 2004 [Favali and Beranzoli (2008)], proving compatibility of GEOSTAR-class observatories with other networks.

All sensors installed on the observatory are managed by dedicated low-power electronics, able to perform the following tasks: (a) management and acquisition from all scientific packages and status sensors; (b) event detection; (c) preparation and continuous update of hourly data messages; (d) management of bidirectional communications via hydro-acoustic telemetry link (including transmission of seismic wave forms); (e) actuation of commands received (e.g., data request, system reconfiguration, restart) and (f) complete data back-up on internal memory. The SN-4 electronics can manage a wide set of data streams with quite different sampling rates tagging each datum according to a unique reference time set by a central high-precision clock.

During its first mission in Corinth Gulf SN-4 was equipped with a 3-C broad-band seismometer, an hydrophone and a methane sensor, with one year autonomous operation with 12-V, 960-Ah lithium battery pack. To reduce disturbance of the frame and electronics, special devices were designed and implemented for installing the seismometer, which is lodged in a dedicated vessel integrated in a separate structure connected to the SN4 by a special mechanical release. To guarantee a good coupling with the sea bottom, the structure is disconnected just after the touch-down and kept linked to the frame by a slack rope. This method of seismometer installation proved to record higher quality data during all the GEOSTAR-class observatory missions. For the Marmara mission the configuration of the SN4 was modified, aiming at better quantifying the temporal relations between fluid expulsion, fluid chemistry and seismic activity along the NAF. The new payload and relevant sampling rates are summarised in Tab.11. The station will be deployed using ship's winch and an acoustic release like in ASSEM mission, but the recovery procedure was

redesigned, i.e. station will be recovered by a rope released by an acoustic command, letting the operations be performed by ship-of-opportunity. To achieve this result, the total weight in water was reduced to 0.15kN ( $\approx 150$  kg) from the 500kg in air by installing 8 benthospheres on the frame and adopting new lighter vessels for batteries and Electronics. This new fitting will make recovery and redeployment easier at the end of scheduled 6 months of activity. For future applications, SN-4 can be re-configured to operate as cabled observatory for permanent long-term real-time monitoring of the Marmara Sea to study relationship between fluids and seismicity.

The configuration for the ESONET Marmara Mission (Fig.15) was as follows:

- Communication with ship of opportunity by Sercel High Speed Acoustic Modem for data transfer and system's control
- Deployment via winch and acoustic release and recovery via pop-up system (recall buoy canister) actuated by acoustic release
- Autonomy about 6 months; Power: 12V,1920 Ah primary lithium pack; data storage 30GB HD
- Dimensions: 2000 x 2000 x 2000 mm; Weight: 6.5 kN in air, 1.5 kN in water

SENSOR	MODEL	SAMPLING RATE
Seismometer	Guralp CMG-40T	100Hz
Current meter	Nobsvka MAVS-3	5 Hz
CTD	SBE-16 Plus	1 sample/10min
Turbidimeter	Wet Labs Echo-BBRTD	1 sample/10min
CH <sub>4</sub> #1	Franatech METS	1Hz
Oxygen	Aanderaa Oxygen Optode 3830	1Hz

Table 11: INGV's SN-4 payload.

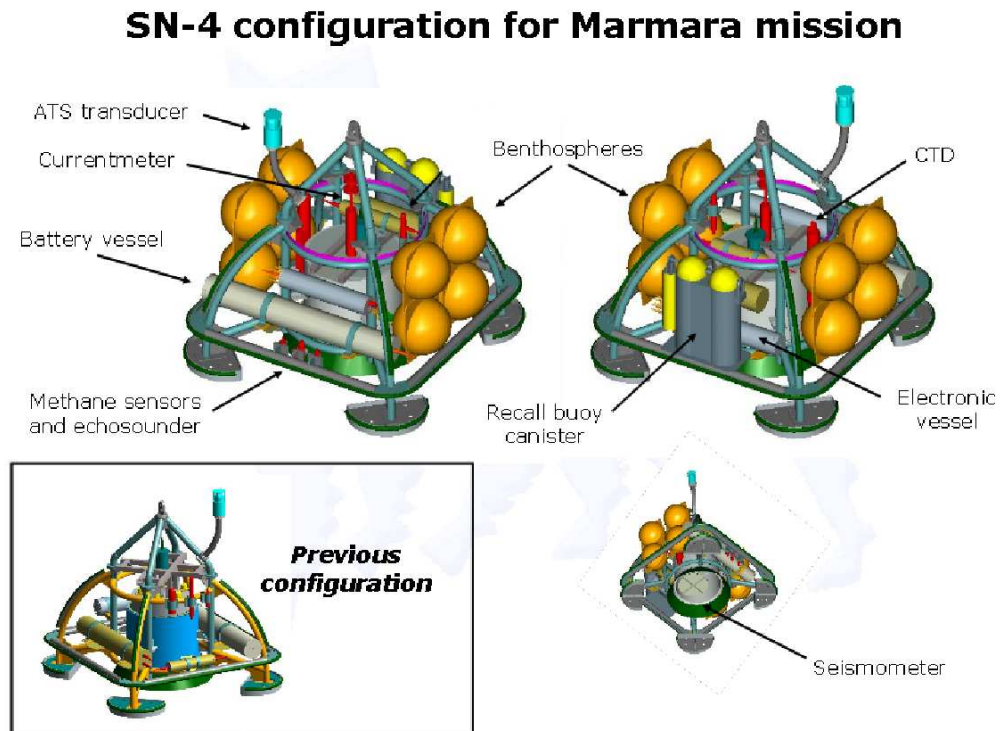

Figure 15: SN4 sketches.



### 3.5 MEDUSA TOWED OBSERVATORY

INGV MEDUSA (see Fig.16) is a towed inspection system that can be managed by a ship of opportunity, being deployed by a small winch delivering about 600m of electrical and strength cable. Once deployed in seawater, MEDUSA transmits in real-time to its Surface Control Unit all data collected by the installed payload Tab.12 consisting of (a) geochemical sensors measuring gas concentrations (oxygen, methane), (b) water physical parameters (CTD), (c) system status and telemetry data and (d) images from an underwater camera. The Surface Control Unit (SCU) contains electronic equipment and power modules to control the underwater vehicle, accommodated into a transportable 14U industrial rack (weight 100 kg, 230 VAC 50 Hz, 1.2 kW). A GPS system provides positioning and accurate timing to the system.

During deployments, a hose was wrapped on the umbilical at the frame and to a surface pump for water sampling at interesting quotes or whenever dictated by Real Time data, especially increase in methane concentration.

SENSOR	MODEL	MANUFACTURER
Oxygen sensor	Optode 3830	AANDERAA
methane sensor	K-METS	Franatech
methane sensor	HydroC	CONTROS
H2S electrode		
CTD	Seabird	SBE-19plus
turbidimeter	WET LABS	ECO-BBRTD
Echo sounder	PA500-6	TRITECH
TV camera	Multi SeaCam 1060	DEEPSEA POWER&LIGHT

Table 12: INGV's MEDUSA payload.

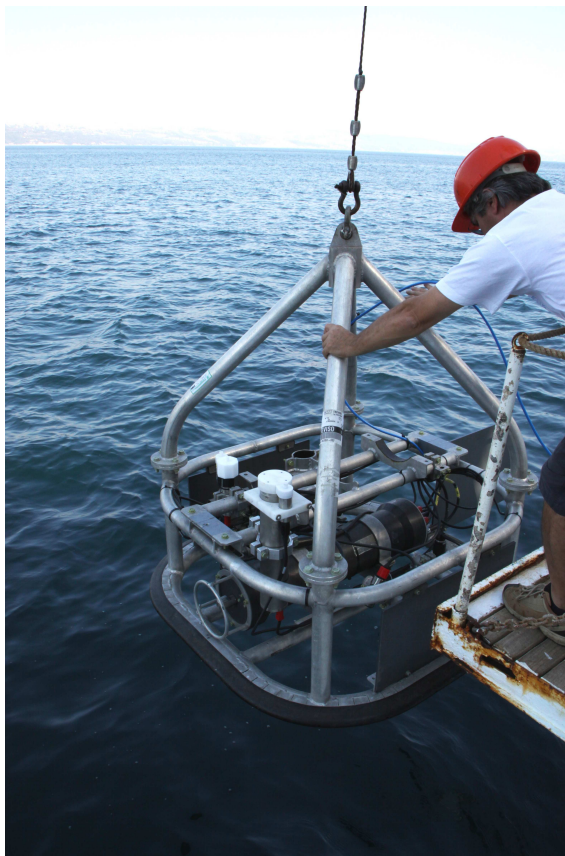

Figure 16: INGV's MEDUSA being deployed.

### 3.6 SEABED SAMPLING

The sea bottom samples were collected with 1.2 Ton gravity corer (Fig.18), the ISMAR's Mod.SW-104 water/sediment corer [Magagnoli A. and Mengoli M. (1995)] (Fig.17) and with a box corer (Fig.17).

The sample locations are shown in Fig.6 and are reported on Tab.13

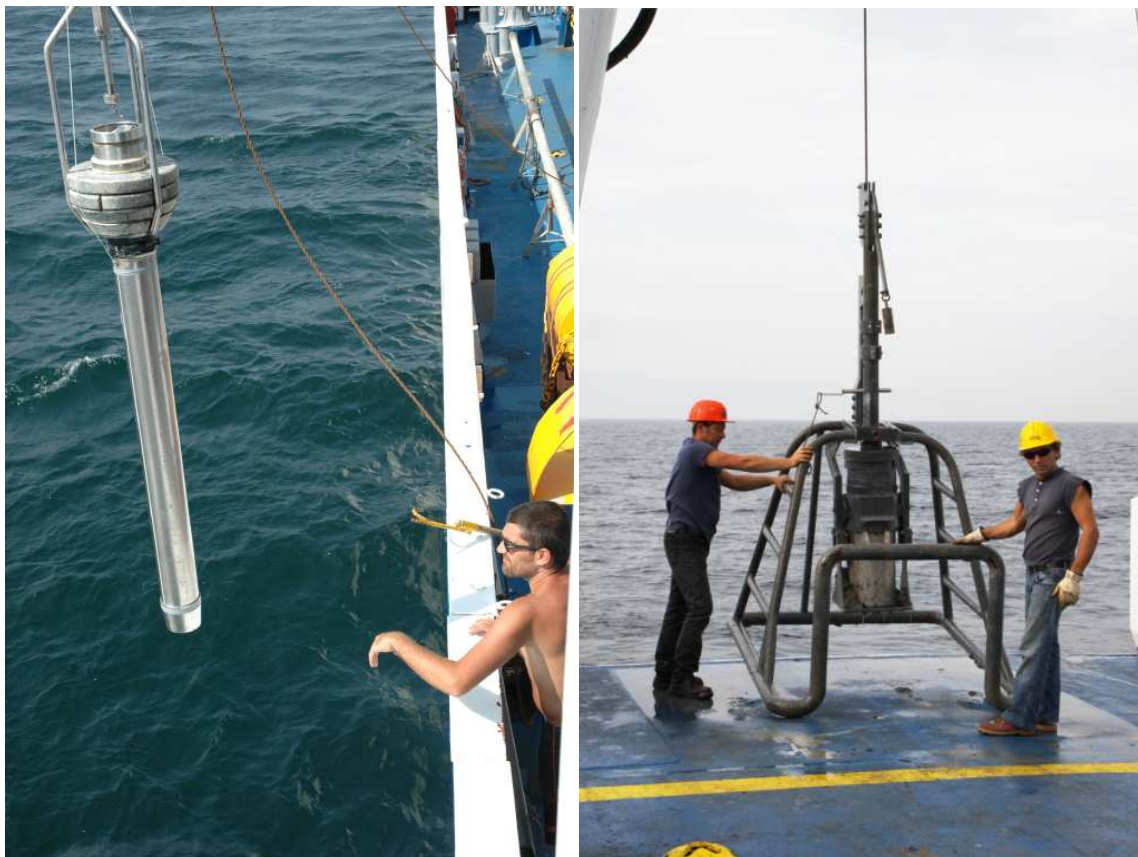

Figure 17: SW-104 water/sediment corer and box corer.



Figure 18: Gravity corer.

LON LAT	DATE_TIME	CORE	LENGTH	COMMENT
2847.8815 4045.5070	2009-09-27T13:18:01	MPZ-01-	3.20m	- -
2847.8665 4045.5046	2009-09-27T15:36:01	PZ-A-	S/N-01	1693 1649
2907.0277 4043.1575	2009-09-28T08:39:32	PZ-B-	S/N-02	1691 1649
2906.9286 4043.1818	2009-09-28T11:09:21	MPZ-02-	3.24m	- -
2907.2033 4044.0456	2009-09-28T13:05:47	PZ-C-	S/N-03	1692 1649
2907.2564 4044.0267	2009-09-28T14:30:23	MPZ-03-	2.22m	- -
2923.1766 4043.6859	2009-09-29T06:19:45	MPZ-04-	2.97m	- -
2923.1742 4043.6853	2009-09-29T07:48:34	PZ-D-	S/N-05	1695 1649
2856.2232 4050.0033	2009-09-29T12:48:18	PZ-E-	S/N-04	1690 1649
2856.1343 4049.9861	2009-09-29T14:04:03	MPZ-05-	3.48m	- -
2923.0715 4043.7790	2009-10-03T06:22:15	MSN-BC01-	0.18m	oxic
2923.0737 4043.7880	2009-10-03T07:02:42	MSN-BC02-	0.24m	anoxic
2923.2642 4043.7372	2009-10-03T08:57:43	MSN-C01-	1.00m,	extruded pw
2923.2519 4043.7479	2009-10-03T10:13:11	MSN-C02-	2.04m	
2923.2456 4043.7445	2009-10-03T11:28:35	MSN-C03-	2.02m	
2923.3125 4043.7381	2009-10-06T08:01:09	MSN-SW01-	0.73m	extruded pw
2923.3166 4043.7361	2009-10-06T08:44:05	MSN-SW02-	0.70m	- -
2927.4719 4043.7841	2009-10-06T10:08:18	MSP-C01-	2.24m	
2927.4790 4043.7832	2009-10-06T11:47:57	MSP-C02-	1.85m	Large
2830.2163 4052.2810	2009-10-07T12:22:24	MEI-C01-	2.73m	
2830.2213 4052.2798	2009-10-07T12:55:30	MEI-SW01-	1.30m	
2830.2238 4052.2782	2009-10-07T13:39:20	MEI-C02-	2.92m	
2832.5955 4056.3491	2009-10-07T14:53:04	MEI-SW02-	0.70m	

Table 13: Bottom sample positions. Latitude, Longitude true position, Time UTC



### 3.7 MISCELLANEOUS

The WGS84 datum, the UTM35N projection and UTC were chosen for navigation and display, and for data acquisition. The time zone was set to the UTC for the instrumental data acquisition. The positioning maps and bathymetric images were produced with GMT [Wessel and Smith (1995)] and Globalmapper. The multibeam data were pre processed on board by the GMT software and ISMAR's routines and scripts, using the SIS production DTMS, after conversion to the ASCII format.

Bathymetric data were complemented by the IFREMER's DTM of Sea of Marmara [Le Pichon et al.(2005)]. On-land SRTM topography data was used for mapping, structural analysis, after conversion to NETCDF GMT grid files.

The computing center employed INTEL based PC running the GNU-Linux in addition to portable computer for data acquisition and personal processing. The Linux machines were used as data repositories using the SAMBA software, providing also network services like WWW, DHCP and NAT.

Photographs and video were taken by digital cameras and video-camera by INGV dedicated personnel and by all participants.

## 4 DESCRIPTION OF DEPLOYMENTS AND OF DATA COLLECTED

Initial results are presented, in order to address the importance of the preliminary findings and processing sequence of the data acquired.

### 4.1 OBS AND PIEZOMETER DEPLOYMENT

The OBS were deployed after mapping by multibeam around the proposed sites, in order to identify most suitable areas. The maps in the appendix report the positions for each of them. The proposed sites for piezometers were (a) investigated by CHIRP and multibeam, and by gravity coring. Figure 19 show the CHIRP profiles closer to the deployment sites.

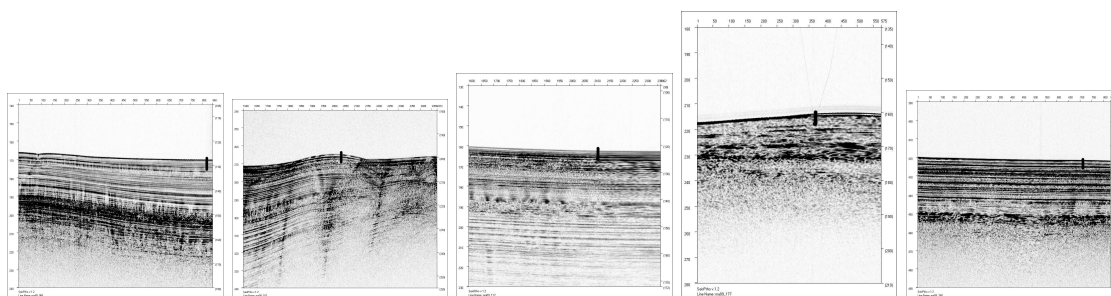

Figure 19: CHIRP profiles relative to the Piezometer's deployment. From left to right, PZ-A, PZ-B, PZ-C, PZ-D, PZ-E.

### 4.2 SN-4 OBSERVATORY DEPLOYMENT

The deployment of the INGV's SN-4 at the entrance of the Gulf of İzmit took place afternoon of 2009-10-04 after intensive mapping by multibeam and chirp and coring by box-corer and gravity corer (Fig.25). The final destination was chosen to be very close to the NAF, on a flat bottom 165m depth on the center of the steep EW striking valley merging a few hundred m to the W with the Darica Canyon.

After the launch at sea (Fig.20) the SN4 touched down on bottom at 15:56:16 (Fig.21 and 22), a few m of cable were layed out and the system was interrogated by acoustic modems. After several attempts with no response from the station, the cable was released at 16:14:47. Ship moved then away some hundred m and after some retries the SN-4 responded at 18:46:00, providing data of orientation ( $142^\circ$ ) and of tilt ( $7-9^\circ$  well within specification). The day after the area was again investigated by the MEDUSA, and the SN-4 was seen by the TV camera several times around 07:00:00 laying vertical on the bottom (Fig.23 and 24). A further high resolution mapping by multibeam was then performed attempting to find the target on bottom.

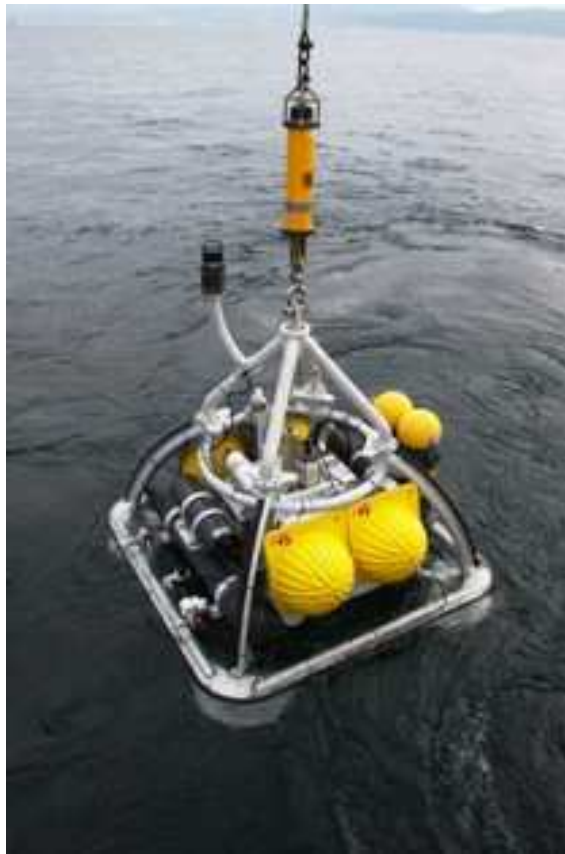

Figure 20: SN-4 being deployed.

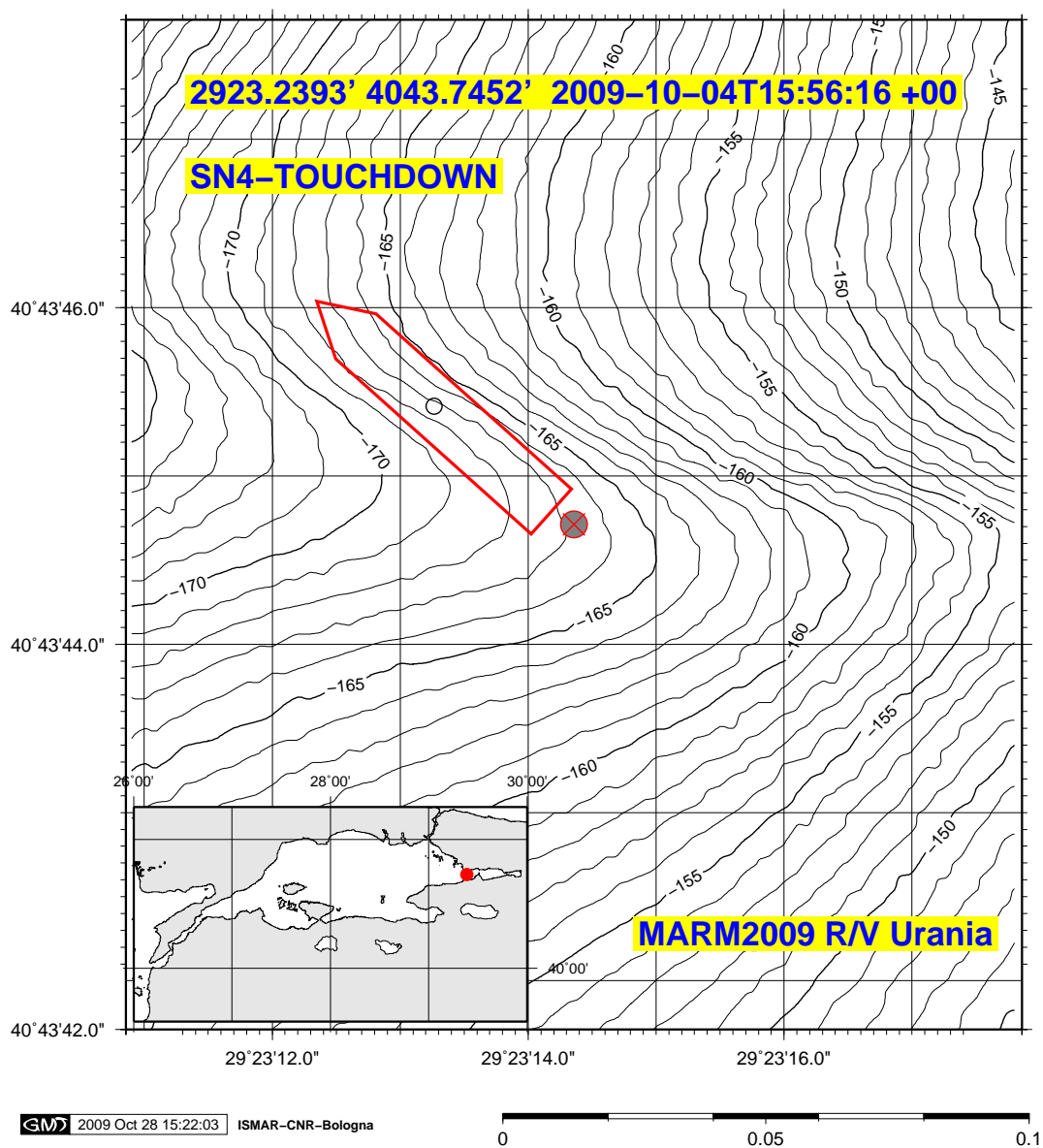

Figure 21: Map showing the position of the SN4 on bottom (gray circle and cross). Hollow circle is the ship's reference point position.

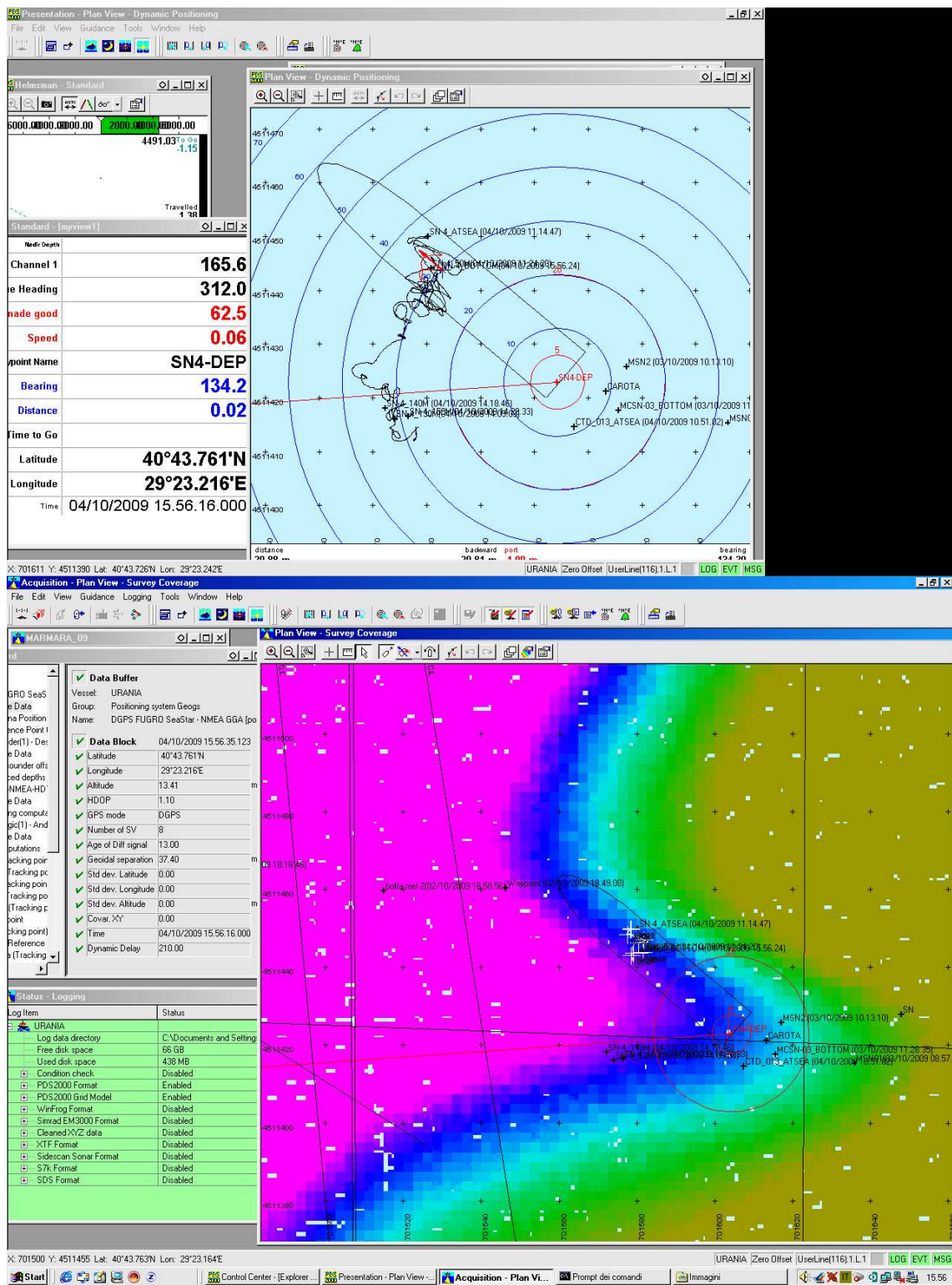

Figure 22: Snapshot of the navigation system's data at the touchdown of SN4.

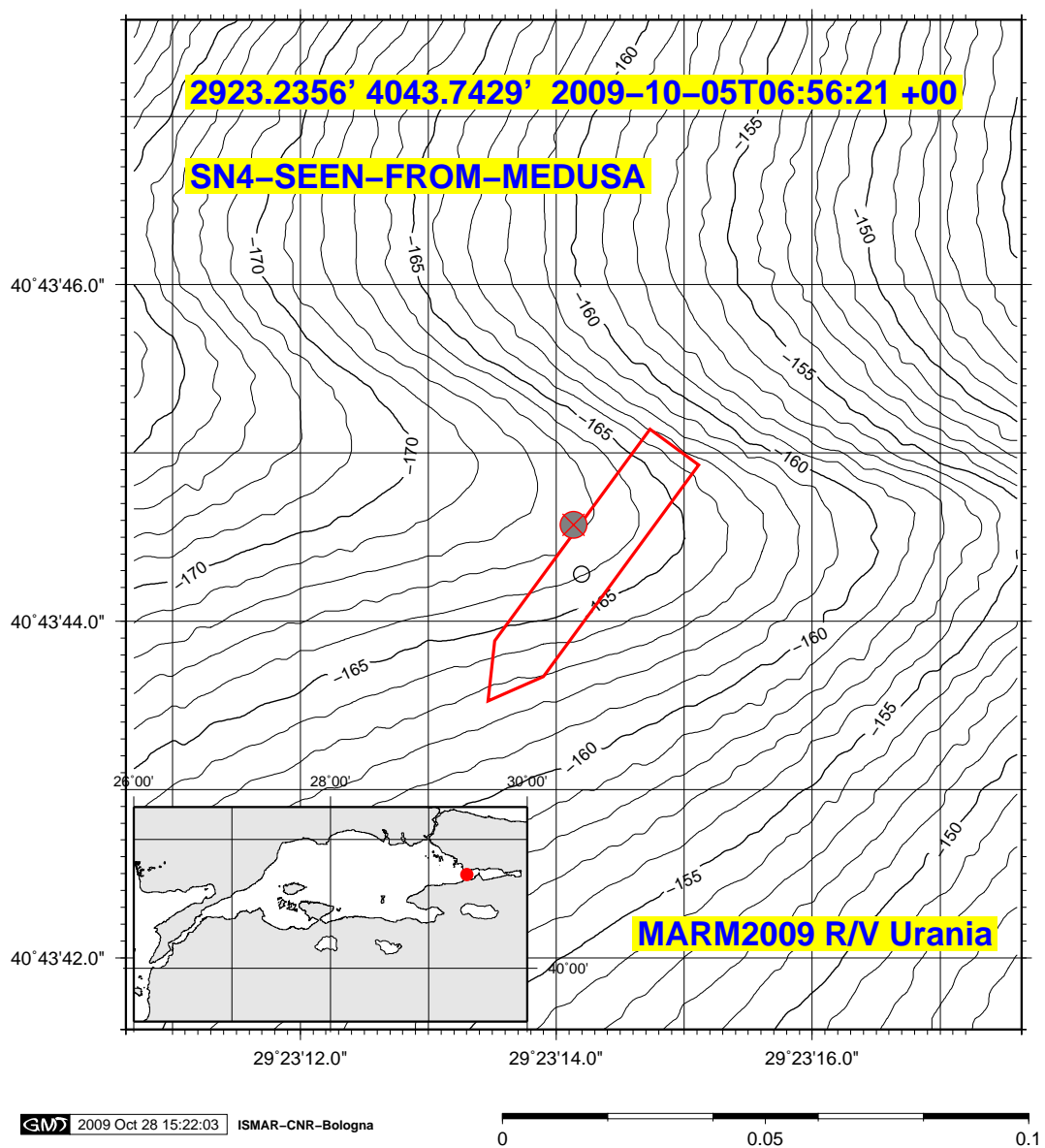

Figure 23: Map showing the position of Medusa during the seeing of SN4 on the vertical.



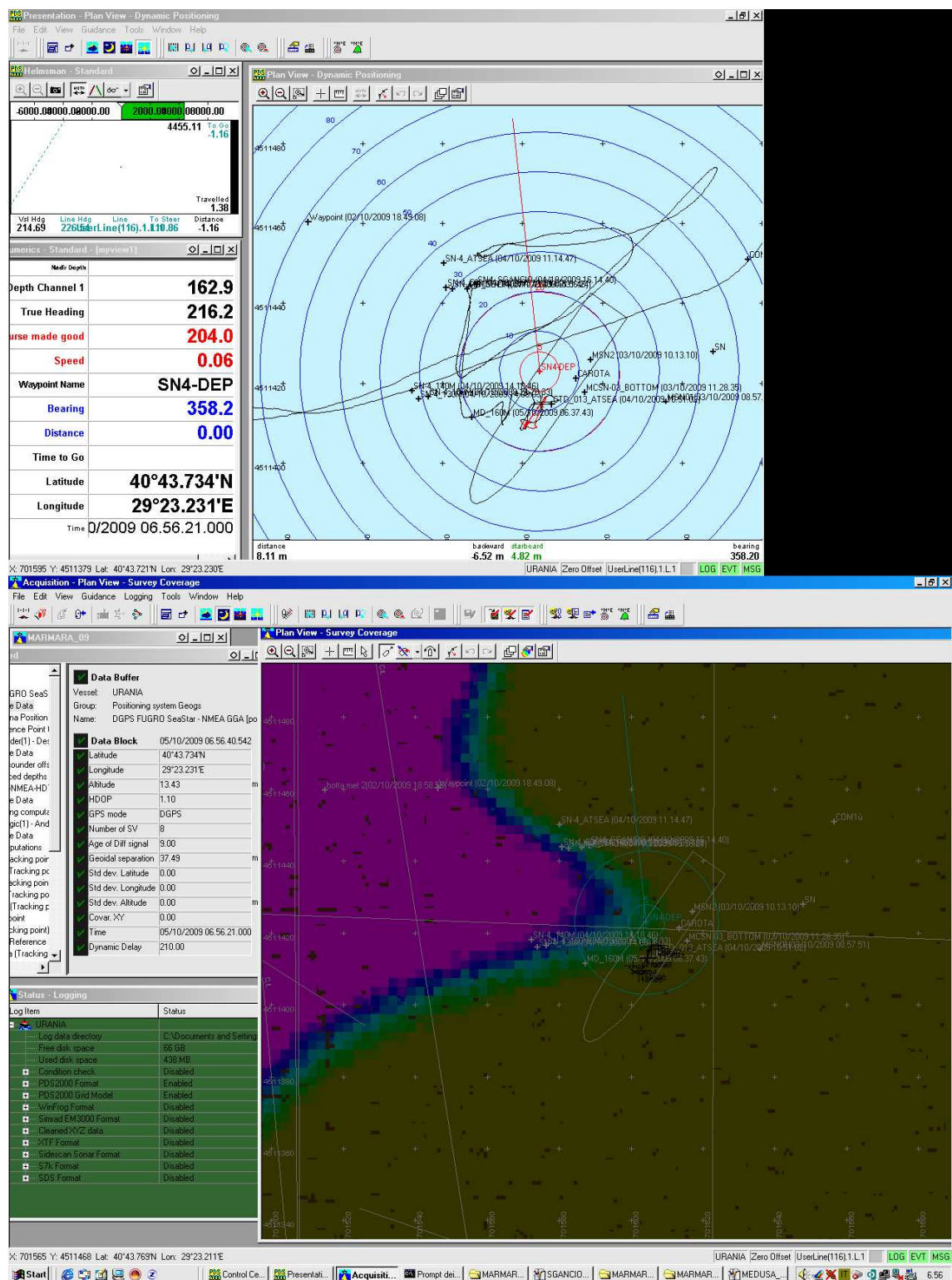

Figure 24: Snapshot of the navigation system's data of the Medusa on top of SN4.

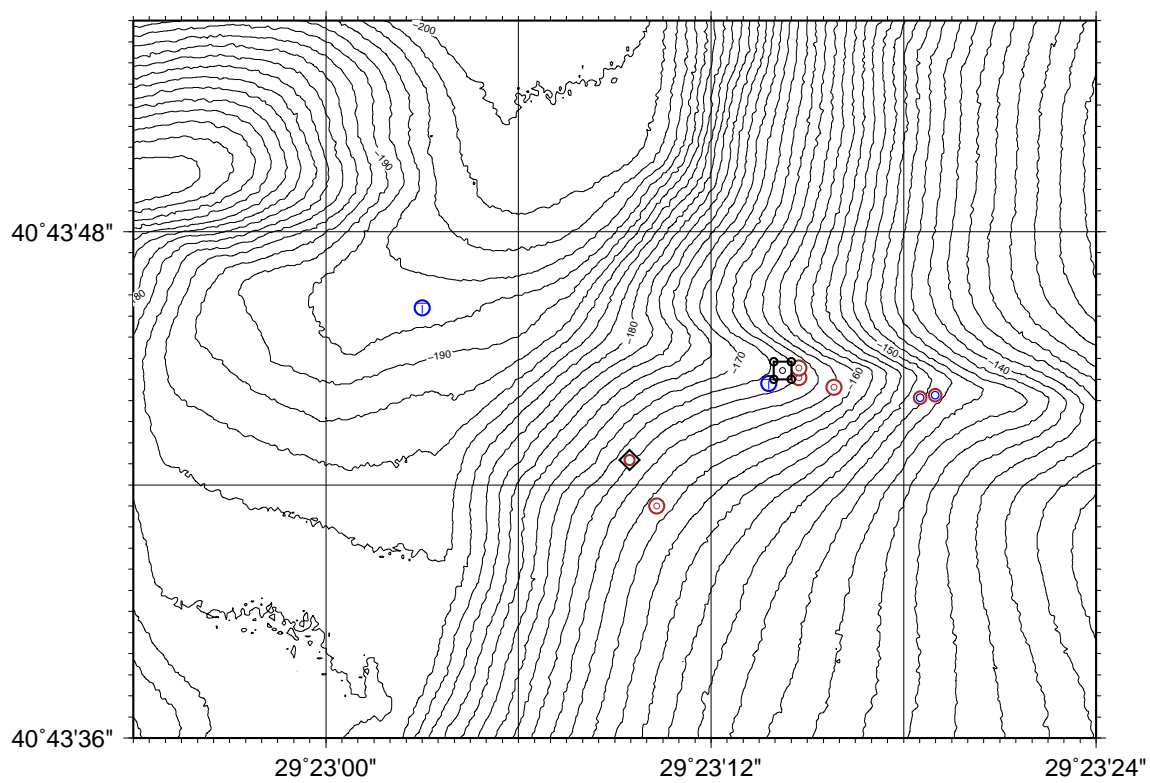

Figure 25: The area of SN-4 deployment.

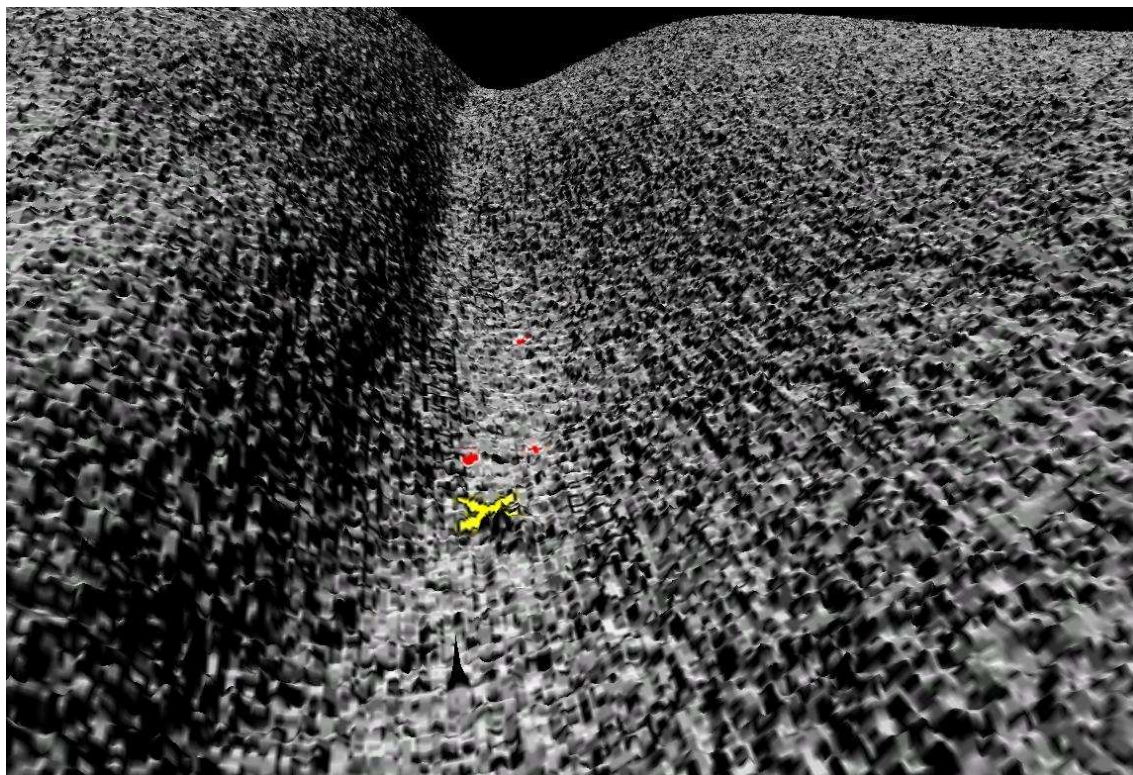

Figure 26: 3D swath bathymetric map collected after the deployment of station. SN4 is visible (in yellow) at the seafloor.



### 4.3 MEDUSA PROFILING

The MEDUSA towed observatory was launched in the areas of the Darica Canyon, of the Structural High and of the Mud volcanoes to the W of Hersek peninsula, with the aim of obtaining visual information on the bottom morphology and instrumental oceanographical and geochemical data. Figures 27, 28 and 29 shows the runlines in the Darica Canyon, and Hersek Peninsula sites, known to be possible degassing areas. The system was generally towed at very low speed or drifting at 0.5-1.5m above bottom, but in particular cases when it was raised up for sampling water at determined levels.

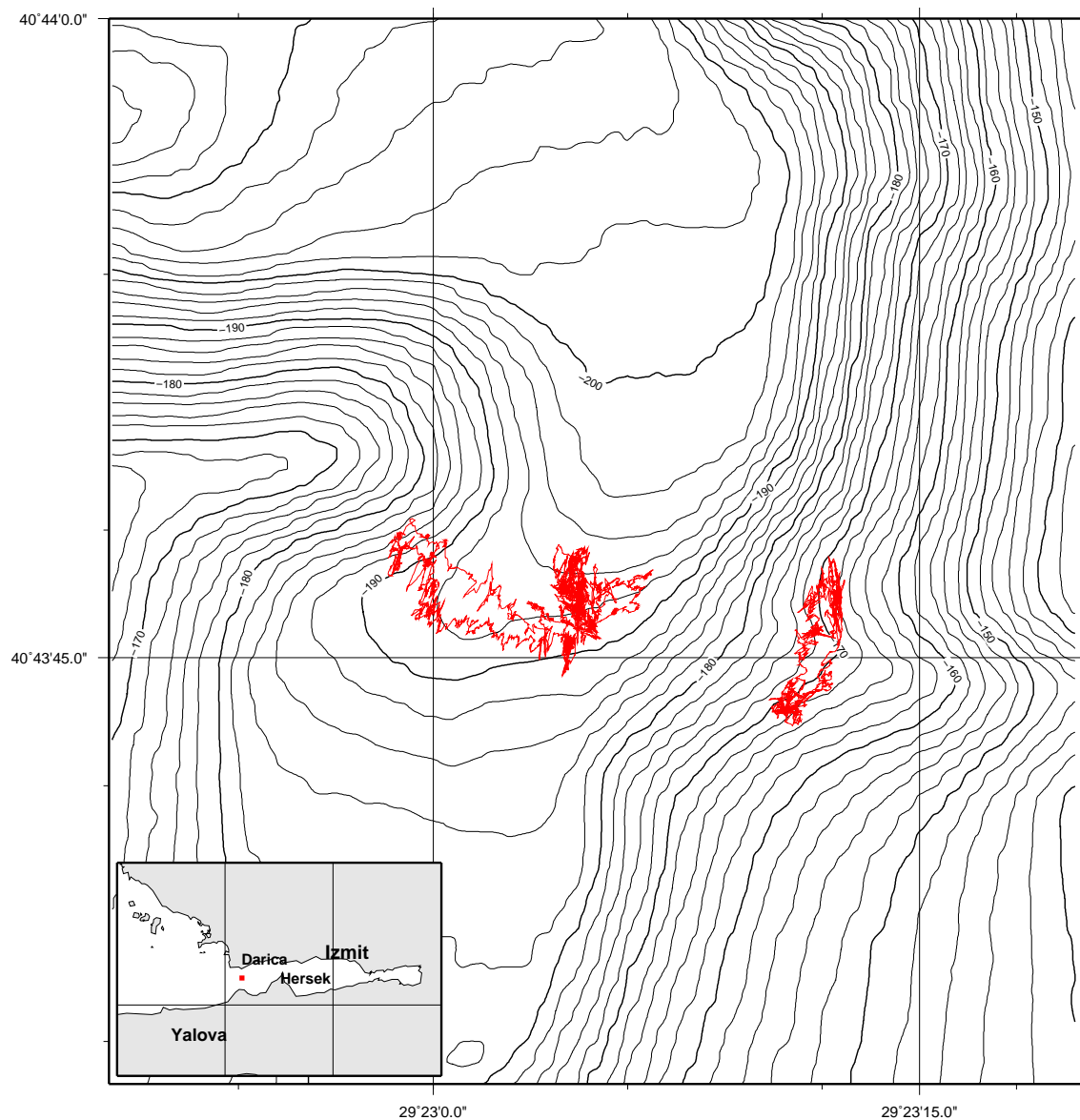

Figure 27: MEDUSA, Darica Canyon site.

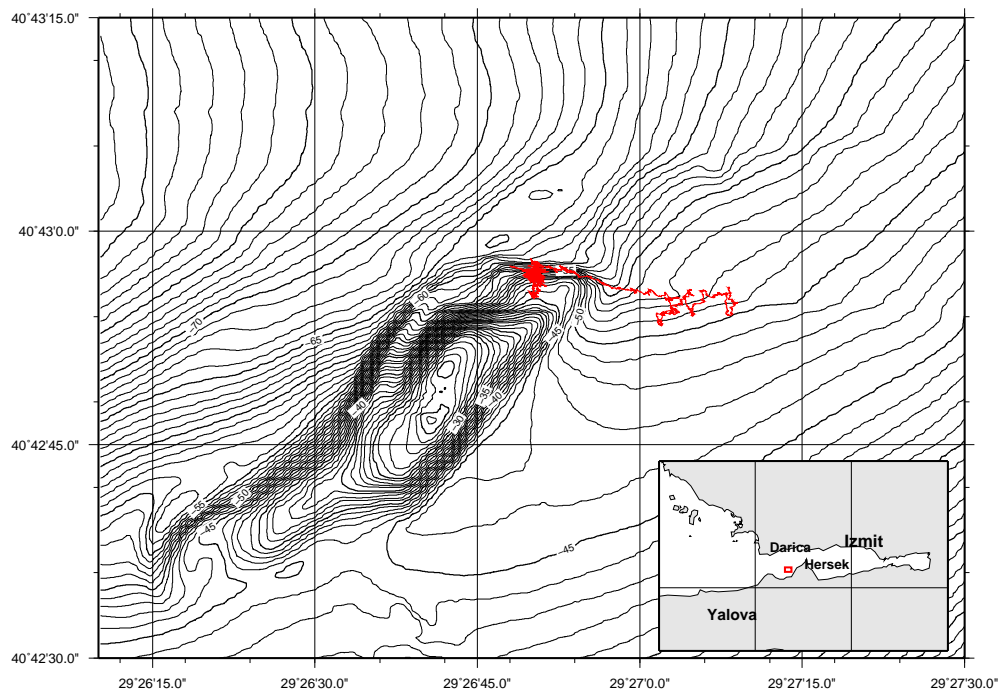

Figure 28: MEDUSA, Hersek site.

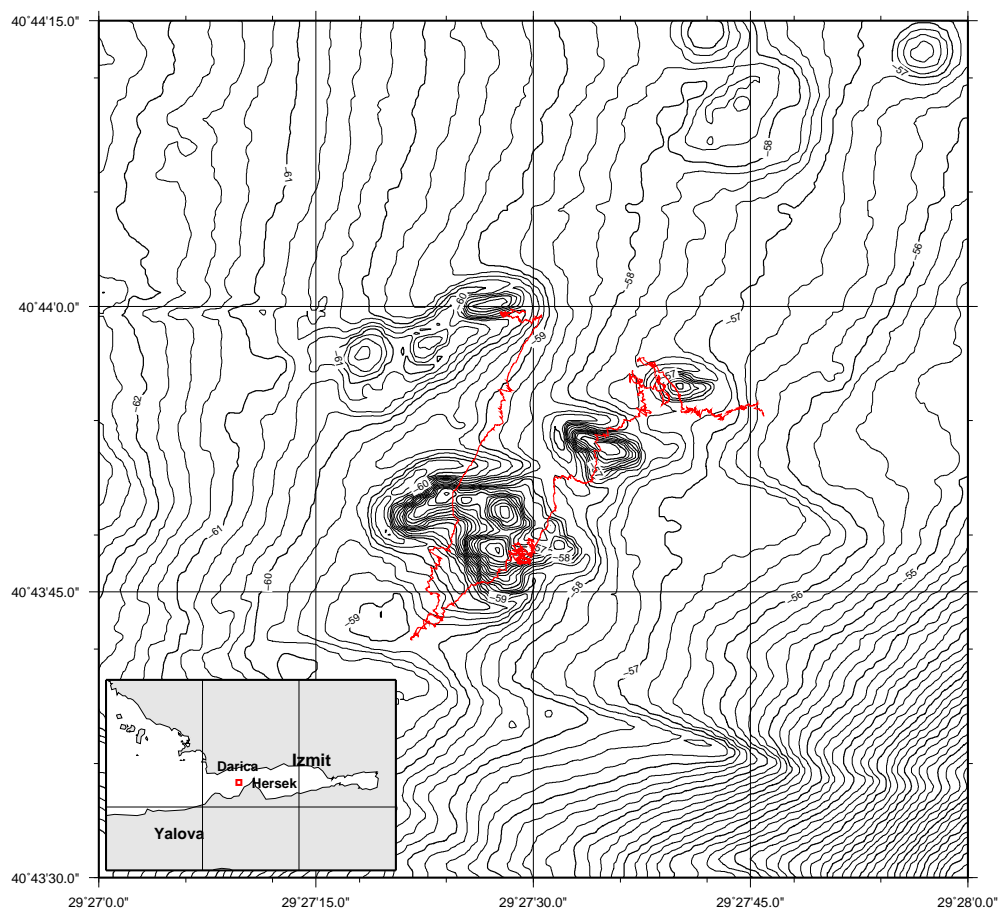

Figure 29: MEDUSA, Hersek site.

#### 4.4 SEABED SAMPLING

Tables 13 and 14 show the positioning data and description of samples.

During the First leg 5 gravity corers were taken close to the Piezometer's location on bottom and will be analyzed at IFREMER for geotechnical and sedimentological determinations useful to correlate data of pore pressures time series from the piezometers.

During the Second Leg two box corers, seven gravity cores and four sediment/water interface cores SW-104 [Magagnoli A. and Mengoli M. (1995)] were collected.

The two box corer sampled the area of SN4 near a zone of black patches evidenced by Medusa surveys, aimed also at sampling possible carbonate crusts. The first box corer sampled mud with shell fragments; the second box corer, sampled again mud and also stones, gravel, shell fragments, more compact mud conglomerates, and with black-blue intrusions which were stocked in plastic bags and deep frozen, together with a small core, for possible microbiological investigations. An attempt to measure methane gave negative result. The washed and sieved materials showed black to gray sand to gravel granulometries, shell fragments and normal malacofauna (Fig.30).

STATION	DATE	LENGTH	NOTES
MPZ-01	2009-09-27T13:18:01	3.20m	PZ-A. Çınarcık Basin, W.
MPZ-02	2009-09-28T11:09:21	3.24m	PZ-B. Çınarcık Basin, SE. Lacustrine dehydrated very hard overconsolidated mud, tending to inflate. Suggested stratigraphy and correlation with CHIRP, log and X-RAY.
MPZ-03	2009-09-28T14:30:23	2.22m	PZ-C. Çınarcık Basin, SE. Same as MPZ-02
MPZ-04	2009-09-29T06:19:45	2.97m	PZ-D, Chirp MA09-176,177. SN4 site, about 100m S of NAF, point of penetration seen on CHIRP, good for correlation. Base of holocene at bottom, overconsolidated sediment
MPZ-05	2009-09-29T14:04:03	3.48m	PZ-E. Çınarcık Basin, NE.
MSN-BC01	2009-10-03T06:22:15	0.18m	Box corer. Oxic. mud, shell fragments. Washed and sieved.
MSN-BC02	2009-10-03T07:02:42	0.24m	Box corer. Anoxic. sandy mud, shells, shell fragments, stones, pebbles, black intrusions. Core, black sediment in plastic bags, deep freezer.
MSN-C01	2009-10-03T08:57:43	1.00m	SN4 site. Extruded, pore waters
MSN-C02	2009-10-03T10:13:11	2.04m	SN4 site.
MSN-C03	2009-10-03T11:28:35	2.02m	SN4 site.
MSN-SW01	2009-10-06T08:01:09	0.73m	SN4 site. Extruded pore waters
MSN-SW02	2009-10-06 08:44:05	0.70m	SN4 site.
MSP-C01	2009-10-06T10:08:18	2.24m	Mud Volcano, Hersek.
MSP-C02	2009-10-06T11:47:57	1.85m	Mud Volcano, Hersek. Large oyster at bottom with other shell fragments.
MEI-C01	2009-10-07T12:22:24	2.73m	Humburgaz Basin, very close to NAF.
MEI-SW01	2009-10-07T12:55:30	1.30m	Humburgaz Basin, very close to NAF.
MEI-C02	2009-10-07T13:39:20	2.92m	Humburgaz Basin, very close to NAF.
MEI-SW02	2009-10-07T14:53:04	0.70m	Büyükçekmece, flood

Table 14: Core sample description. BC=Box corer, SW=Sediment/water.



Figure 30: Malacofauna inventory from MBC02, Darica Canyon.

Tree gravity cores (MASN\_1, MASN\_2, MASN\_3) were also collected near the SN4 planned deployment site. The first one was immediately sub-sampled for the pore water extraction (Tab. 15). The pore waters were obtained by a squeezer with extraction capacity of four sample in each cycle for slice thickness from minimum of 2 cm to a maximum of 3 cm. Below the 37-39 cm level the long time required for the extraction and the cleaning face between cycles, did not assure the preservation of sulphides in the sample, therefore the sulphide aliquots were not stocked for the successive slices. On 2009-10-06 two SW-104 (MASNSW01, MASNSW02) were sampled in the SN4 area, and the first one was immediately sub-sampled for the pore water extraction by centrifuge (Tab.16), while the bottom water was preserved in glass vials with butyl stoppers.

Table 17 summarize the aliquots type, the adding solvents and the conservation method.

Core MSNSW02, sampled with PVC liner and stocked at 4°C, during the recovery lost the bottom water, but the structure of the core was preserved because the sediment (plastic, compact and poorly hydrated) functioned like a stopper.

Successively, on 2009-10-07 (a) two gravity cores were sampled in mud volcano area, near Hersek (MSIP01 and MSIP02), (b) one SW-104 (MEISW01) and two gravity cores in Kumburgaz basin and (c) one SW-104 (Flood01) in the area of the recent flooding deposits in front of Büyükçekmece. The bottom of core MSIP02 contained a well preserved oyster, 10 cm size (Fig.31).

The cores of second leg have been taken in two copies, and were split between ISMAR and ITU.





Figure 31: Mud Volcano Area, Hersek. Oyster found in the bottom of core..



CM	MM	O	S	TM	N	F	NOTE		
00-01	X	-	-	-	-	X	Sampled only the aliquot for major metals and trace metals analysis		
01-02	X	-	-	-	-	X			
02-03	X	-	-	-	-	X			
04-05	X	X	X	X	X	X			
05-06	X	X	X	X	X	X			
06-07	X	X	X	X	X	X			
07-08	X	X	X	X	X	X			
08-09	X	X	X	X	X	X			
09-10	X	X	X	X	X	X			
10-15						X			
15-17	X	X	X	X	X	X			
17-22						X			
22-24	X	X	X	X	X	X			
24-29						X			
29-31	X	X	X	X	X	X			
31-37						X			
37-39	X	X	X	X	X	X		Change 3d section	
39-44						X			
44-47	X	X	X	X	X	X		Sediment plastic (less water) the squeezer needed 2 hours for pore water extraction	
47-52						X			
52-54	X	X	X	X	X	X			
54-64						X			
64-67	X	X	X	X	X	X			
67-77						X			
77-80	X	X	X	X	X	X			
80-90						X			
90-93	X	X	X	X	X	X			
93-103						X			
103-106	X	X	X	X	X	X			
106-129						X			
129-132	X	X		X	X	X			The sulphide aliquot was not stocked in the successive sample Change 2nd section
132-157						X			
157-160	X	X		X	X	X			
160-185						X			
185-188	X	X				X			
188-213						X			
213-216	X	X				X			
216-232						X	Change section 2nd (bottom plus top of section 1)		
232-241						X			
241-244						X	No pore water		
244-269						X			
269-272						X			
272-297						X			
297-300						X			
300-325						X			
325-328						X			

Table 15: Core MSN-C01. Subsampling table. MM=major metals; O= chloride; S= sulfide; TM = trace metals; N= natural; F= sediments;

CM	MM	O	S	TM	N	F	NOTE
0-0.5	X	X	X	X	X	X	Yellow color with some black intrusion but no sulphide smell
0.5-2.5	X	X	X	X	X	X	
2.5-4.5	X	X	X	X	X	X	
4.5-6.5	X	X	X	X	X	X	
6.5-8.5	X	X	X	X	X	X	
8.5-10.5	X	X	X	X	X	X	More compact changing sedimentation type and water content
10.5-12.5	X	X	X	X	X	X	
12.5-14.5	X	X	X	X	X	X	
14.5-16.5	X	X	X	X	X	X	
16.5-18.5	X	X	X	X	X	X	
18.5-20.5	X	X	X	X	X	X	
20.5-25.5	X	X	X	X	X	X	
25.5-30.5	X	X	-	X	X	X	
30.5-35.5	X	X	-	X	X	X	
35.5-40.5	X	X	-	X	X	X	
40.5-45.5	X	X	-	X	X	X	Shell fragments
45.5-50.5	X	X	-	X	X	X	
50.5-60.5	-	-	-	-	-	X	No pore water
60.5-70.5	-	-	-	-	-	X	No pore water
70.5-73.5	-	-	-	-	-	X	No pore water

Table 16: Core MSN-SW01. Subsampling table. MM=major metals; O= chloride; S= sulfide; TM = trace metals; N= natural; F= sediments;

TYPE	SOLVENT	RATIO ALIQ/SOLV	STOCKED AT
MM	Nitric Acid	1:10	+5°C
TM	Nitric Acid	1:10	+5°C
O	-	-	- 20°C
N	-	-	- 20°C
S	Zn-acetate	1:7.5	-20°C
F	-	-	-20°C"

Table 17: Extrusion of cores. Aliquots type, solvents, conservation.

## 4.5 CHIRP SBP

A quick processing with SEISPRHO [Gasperini and Stanghellini(2009)] was made on board for navigation and geological target selection, other than structural and stratigraphical analysis. Example of the recorded and processed data are shown in Fig.32, 33, 34 and 35.

The data quality ranged from good to very good, with penetration down to 40 m. Two ultra-high resolution closely-spaced grid of profiles were performed in Tuzla, İzmit, Karamürsel and Gemlik gulfs, to obtain information on NAF offsets and slip rates.

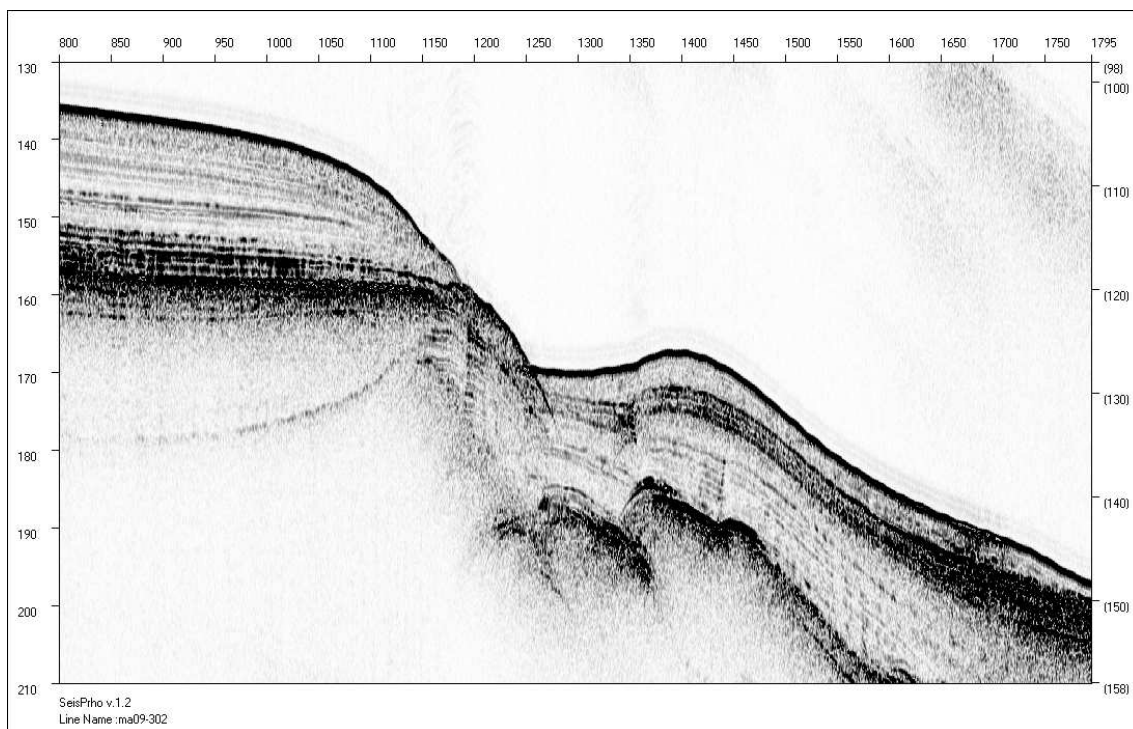

Figure 32: Example of SEISPRHO SEG-Y SBP processed data.

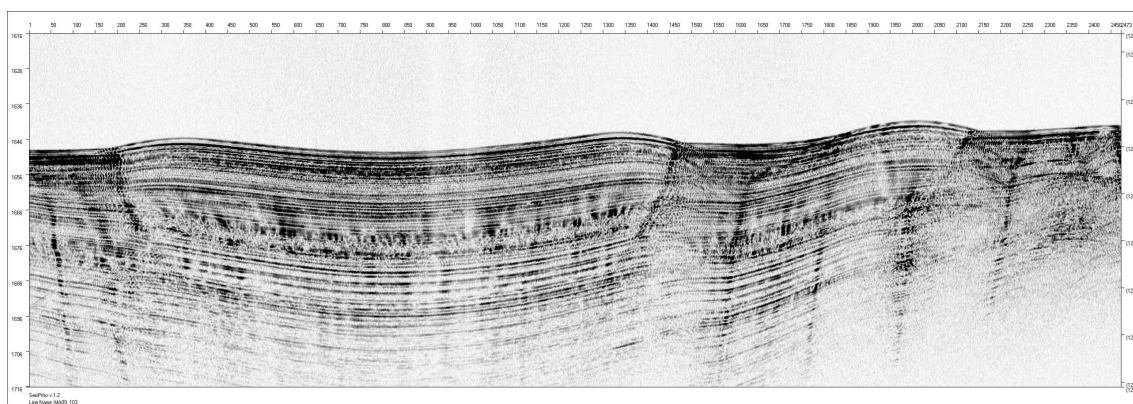

Figure 33: Example of SEISPRHO SEG-Y SBP reprocessed data.

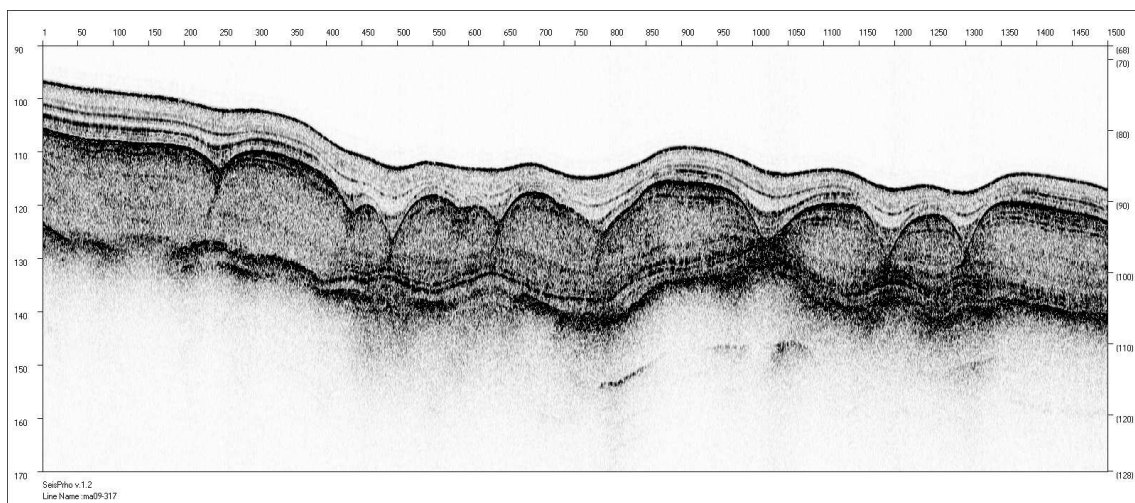

Figure 34: Example of SEISPRHO SEG-Y SBP reprocessed data.

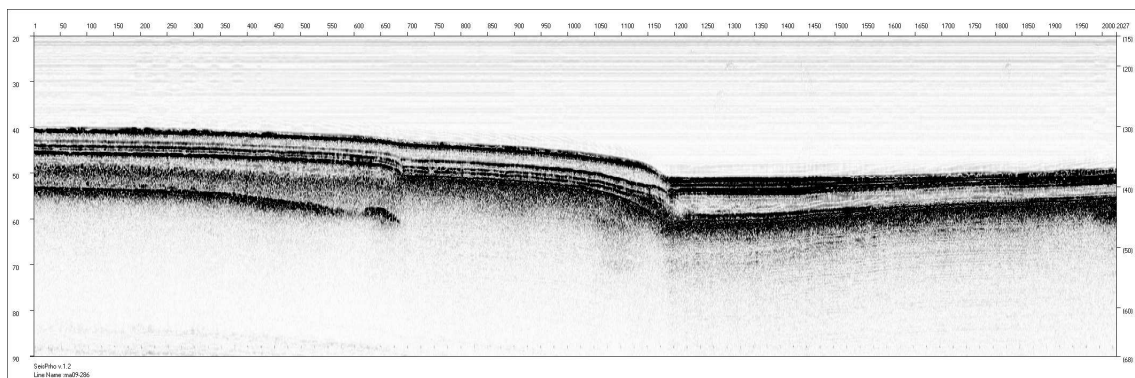

Figure 35: Example of SEISPRHO SEG-Y SBP reprocessed data.

## 5 CONCLUDING REMARKS AND FUTURE WORKS

Main targets of MARAMARA2009 cruise have been reached. A schematic list of first results is indicated.

- **Deployment of Piezometers** The 5 piezometers have been successfully deployed in key sites in the Marmara Sea, Çınarcık basin; first tests of piezometers carried out after deployment with acoustic transponders indicates that the instruments were correctly deployed and are recording; gravity cores collected at piezo-station will be studied at the Geotechnical Lab. of IFREMER in Brest.
- **Deployment of OBS** The 10 OBSs were also deployed correctly at their station, as verified by tests carried out soon after deployment. Four of them have been deployed near piezometers, while the piezometer on the Darica Basin was served by the SN4 seismometer
- **Medusa survey** Several sites were surveyed with the MEDUSA system, including the SN4-station prior deployment, a site with the 1999 earthquake rupture visible at the seafloor and several sites potentially interesting for gas and fluid emissions. Those emissions were detected as anomalous reflections of the sonars in the water column and subsequently investigated using the CH<sub>4</sub> sensors on board of MEDUSA. First results indicate a striking correspondence between those anomalies and the CH<sub>4</sub> contents in the water column detected by the MEDUSA sensors. At each of the CH<sub>4</sub> anomaly sites, water have been also collected by means of a rubber pipe connected with the deployment cable of MEDUSA, and a pump operated from the surface. Sample will be analysed for CH<sub>4</sub> and He isotopes. All of the surveyed sites are located in the Darica basin and include a mud volcanoes field, a strike-slip fault scarp along the main strand of the NAF, and a possible chimney on top of a transpressive high.
- **Deployment of the SN4 observatory**

Deployment of the SN4 station in the Darica Canyon was carried out after high resolution survey of the site using MBES and chirp-sonar. The deployment on the flat base of the canyon, indicated originally as a possible site, was discarded, due to the presence of a markedly uneven seafloor characterized by the presence of debris-flow deposits which included coarse grained material, stones and boulders. Therefore, we concentrated our attention to the fault segment just east of the canyon, and in particular to the narrow rectilinear valley that dissect the Darica basin and mark NAF trace in this area. We finally decided for a location that presented:

- 1 a relatively flat bottom (at the scale of few meters);
- 2 the presence of a CH<sub>4</sub> anomaly;
- 3 a shelter against fishing nets trawling;
- 4 the important character of being the only fault active during the Holocene;
- 5 a narrow principal displacement zone;

After some test with acoustic transponder we were able to communicate with the SN4 station verifying its functioning and attitude. Moreover we carried high-resolution multibeam survey after deployment that enabled us to detect the SN-4 station at the seafloor and map its position (Fig.26)

- **Geophysical data**

First results highlighted the high-resolution of the MB and the Chirp system on board of Urania that fitted perfectly the requirement of accuracy in mapping the subtle trace of active faults in the Sea of Marmara.

Analysis of the data collected during the expedition is under process, and will continue during the forthcoming several months.

No problems were encountered regarding neither the people nor the environment during the cruise.



## References

- [Aksu et al.(2000)] Aksu, A.E., T.J. Calon, R.N. Hiscott, and D. Yasar, *Anatomy of the North Anatolian fault zone in the Marmara sea, western Turkey: Extensional basins above a continental transform*, 2000, GSA Today June 3-7.
- [Alpar and Yaltirak (2002)] B. Alpar and C. Yaltirak, *Characteristic features of the North Anatolian Fault in the eastern Marmara region and its tectonic evolution*, 2002, Marine Geology, 190, 329-350.
- [Ambraseys and Finkel (1991)] Ambraseys, C.F. Finkel, *Long term seismicity of the Istanbul and of the Marmara Sea region*, 1991, Terra Nova, 3, 527-539.
- [Armijo et al.(1999)] Armijo R., Meyer B., Hubert A., Barka A., *Westward propagation of the North Anatolian fault into the northern Aegean: timing and kinematics*, 1999, Geology, 27, 267-270.
- [Armijo et al(2002)] Armijo R., Meyer B., Navarro S., King G., Barka A., *Asymmetric slip partitioning in the Sea of marmara pull-apart: a clue to propagation processes of the North anatolian Fault?*, 2002, Terranova, Vol.14,80-86.
- [Armijo et al.(2005)] Armijo, R. Pondard, N. Meyer, B. Mercier de Lepinay, B. Ucar, G., Malavieille, J. Dominguez, S., Gustcher, M-A. Beck, Çağatay, N. Cakir, Z., Imren, C., Kadir, E. and Natalin, and MARMARASCARPS cruise party, *Submarine fault scarps in the Sea of Marmara pull-apart (North Anatolian Fault): implications for seismic hazard in Istanbul*, 2005, Geochem., Geophys., Geosyst., 1-29.
- [Barka and Kadinsky-Cade (1988)] A. Barka, K. Kadinsky-Cade, *Strike-slip fault geometry in Turkey and its influence on earthquake activity*, 1988, Tectonics, 7, 663-684.
- [Barka (1992)] Barka A.A. , *The North Anatolian fault zone*, 1992, Annales Tectonicae, 6, 164-195.
- [Becel et al.(2004)] Becel, A.P., Charvis, P., deVoogd, B., Galv, A.,Hirn, A., Laigle, M., Lepine, J., Murai, Y., Ozalaybey, S.,Sapin, M., Shmamura, H., Singh, S., and Taymaz, T., *Seismic structure and activity of North Anatolian Fault in the Sea of Marmara from the Seismarmara Leg 1 Seismic Survey*, 2004, EOS Trans., 85(47), Fall Meetng., Suppl., Abstract S52A-04.
- [Bortoluzzi et al.(2001,a)] G.Bortoluzzi, A.Polonia, M.Cormier, N.Çağatay, E.Bonatti, L.Seeber, A.Biasi, P.Fabretti, D.Penitenti,E.Omer, H.Kurt, N.Ozer, B.Tok, F.Satici, E.Bartolini, A.Boschetti, A.Catarinelli, *Geophysical and geological studies in the sea of Marmara. Report on morphobathymetric, seismic, and coring investigations during cruise marmara2000 with R/V Odin Finder*,2001, Rapporto Tecnico IGM N.69, 35pp. URL: projects.bo.ismar.cnr.it.
- [Bortoluzzi et al.(2001,b)] G.Bortoluzzi L.Gasperini M.Ligi E.Bonatti L.Capotondi A.Biasi G.Marozzi A.Magagnoli M.Busetti G.Serpi M.Cormier C.McHugh L.Seeber W.Ryan N.Cagatay O.Emre K.Sarikavak C.Imren N.Okay K.Eris E.Hacioglu M.Simsek A.Bais, P.Scotto di Vettimo, *Geophysical and geological studies in the sea of Marmara. Report on morphobathymetric, seismic and coring investigations during cruise M2001 with R/V Urania*, 2001, Rapporto Tecnico IGM N.70, URL: projects.bo.ismar.cnr.it.
- [Cagatay et al.(1998)] M.N. Cagatay, N. Gorur, B. Alpar, R. Saatçilar, R. Akkok, M. Sakinc, H. Yuce, C. Yaltirak and I. Kuscu, *Geological evolution of the Gulf of Saros, NE Aegean Sea*, 1998, Geo-Marine Letters, 18: 1-9.
- [Cagatay et al.(2000)] M.N,Cagatay, N.Gorur, A. Algan, C.J. Eastoe, A. Tchapylyga, D. Ongan, T.Kuhn, I. Kuscu, *Late Glacial-Holocene palaeoceanography of the Sea of Marmara: timing of connections with the Mediterranean and the Black Sea*, 2000, Marine Geology, 167:191-206.
- [Cagatay et al.(2003)] M.N.Cagatay, N. Gorur, A. Polonia, E. Demirbag, M. Sakinc, M.H. Cormier, L.Capotondi, C. McHugh, O.Emre and K. Eris, *Sea-level changes and depositional environments in the İzmitGulf, eastern Marmara Sea, during the late glacial Holocene period*, 2003, Marine Geology, Volume 202, 3-4, 159-173.

- [Cagatay et al.(2006)] M.N.Cagatay, N. Gorur, R. Flecker, M. Sakinc, C. Tunoglu, R. Ellam, W. Krijgsman, S. Vincent and A. Dikbas *Paratethyan-Mediterranean connectivity in the Sea of Marmara region (NW Turkey) during the Messinian*, 2006, *Sedimentary Geology*, Vol. 188-189, pp. 171-187
- [Cagatay et al.(2009)] Cagatay, M. N.,Eris, K., Ryan, W.B.F., Sancar, U., Polonia, A., Aker, S. Biltekin,D., Gasperini, L., Gorur, N. Lericolais G., Bard, E., *Late Pleistocene-Holocene evolution of the northern shelf of the Sea of Marmara*, 2009. *Marine Geology*, 265: 87-100.
- [Caress and Chayes (2004)] Caress, D. and Chayes, D., *MB-SYSTEM Release 5*, 2005, URL: [www.ldgo.columbia.edu/MB-System](http://www.ldgo.columbia.edu/MB-System).
- [Celebi et al.(2005)] M.Celebi (Scientific Editor) S.Akkar, U.Gulerce, A.Sanli, H.Bundock, A.Salkin, *Main shock and aftershock records of the 1999 İzmitand Duzce, Turkey earthquakes*, 2005, USGS Open-File Report 01-163. URL:[geopubs.wr.usgs.gov/open-file/of01-163](http://geopubs.wr.usgs.gov/open-file/of01-163).
- [Cormier et al.(2006)] Cormier M.H., Seeber L. McHugh C.M.G., Polonia A.,Cagatay N., Emre O., Gasperini L., Gorur N., Bortoluzzi G., Bonatti E., Ryan W.B.F. and Newman K.R, *The north anatolian fault in the gulf of izmit (Turkey):rapid vertical motion in response to minor bends of a non-vertical continental transform*, 2006, *Journal Of Geophysical Research. Planets*. vol. 111 ISSN: 0148-0227. doi:10.1029/2005JB003633
- [Demirbag et al.(2003)] E. Demirbag, C. Rangin, X. Le Pichon, A.M.C. Sengor, *Investigation of the tectonics of the Main Marmara Fault by means of deep-towed seismic data*, 2003, *Tectonophysics*, 361, 1-19.
- [Favali and Beranzoli (2008)] Favali P. and Beranzoli L.,*The GEOSTAR Technology*, ESO NEWS, 2009. [www.esonet-noe.org/content/download/39168/311852/file/ESONEWS\\_3.pdf](http://www.esonet-noe.org/content/download/39168/311852/file/ESONEWS_3.pdf)
- [Flerit et al.(2003)] Flerit F., Armijo R., King G.C.P., Meyer B., Barka A., *Slip partitioning in the Sea of marmara pull-apart determined from GPS velocity vectors*, *Geophys.Journal Int.*, 2003, Vol.154, 1-7.
- [Forte et al.(2009)] E. Forte, M. Sukan, M. Pipan, A. Del Ben, L. Gasperini, *Recent Evolution and Seismogenetic Structures of Hersek Peninsula (Turkey) from High-resolution Seismic Reflection Data*, 2009. 71st EAGE Conference, Near Surface Seismics for Geotechnics, Geohazards and E&P I (EAGE).
- [Gasperini and Stanghellini(2009)] Gasperini L. and Stanghellini G., *SEISPRHO: an interactive computer program for processing and interpretation of high-resolution seismic reflection profiles*, *Computers and Geosciences*, n35, pp.1497-1504 (2009).
- [Gasperini et al. (2007)] L. Gasperini, A. Polonia, G. Bortoluzzi, L.G. Bellucci, V. Ferrante. (2007). *Submarine Earthquake Geology: Potential, Limits, Techniques And Results*. In: Atti del Convegno GNGTS. Gruppo Nazionale di Geofisica della Terra Solida. Roma. Nov. 2007.
- [Gasperini et al. (2008)] L. Gasperini, A. Polonia, V. Ferrante, G. Bortoluzzi and L.G. Bellucci *Submarine Paleoseismology and the Marmara Sea case study: a novel approach to the assessment of seismic hazards*. *Rendiconti online Soc. Geol. It.*, Vol. 2 (2008)
- [Geli et al. (2008)] Geli, L., Henry, P., Zitter, T., Dupre, S., Tryon, M., Cagatay, M. N., Mercier de Lepinay, B., Le Pichon, X., engor, A.M.C., Gorur, N., Natalin, B., Ucarus, G., Ozeren, S., Volker, D., Gasperini, L., Burnard, P., Bourlange, S., the Marnaut Scientific Party, 2008. *Gas Emissions And Active Tectonics Within The Submerged Section Of The North Anatolian Fault Zone In The Sea Of Marmara*. *Earth and Planetary Science Letters*, 274, 34-39
- [Gokasan et al.(2001)] E. Gokasan, B. Alpar, C. Gazioglu, Z.Y. Yucel, B. Tok, E. Dogan, C. Guneyusu, *Active tectonics of the İzmitGulf (NE Marmara Sea): from high resolution seismic and multi-beam bathymetry data*, 2001, *Marine Geology*, 175, 273-296.

- [Hubert-Ferrari et al.(2002)] Hubert-Ferrari A., Armijo R., King G., Meyer B., Barka A. *Morphology, displacement, and slip rates along the North Anatolian Fault, Turkey*, 2002, J. Geophys. Res., 107, art. no. 2235.
- [Imren et al.(2001)] Imren C., Le Pichon X., Rangin C., Demirbag E., Ecevitoglu B., Gorur N., *The North Anatolian Fault within the Sea of marmara: a new interpretation based on multi-channel seismic and multibeam bathymetry data*, Earth and Planetary Sc.Letters, Vol.186, 143-158.
- [Kurt (2000)] Kurt H., *Investigation of the Active Tectonism in the Gulfs of Gokova and Saros by Means of Multi-Channel Seismic Reflection Data*, 2000, Ph.D. Thesis (in Turkish with English abstract), Istanbul Technical University, Institute of Science and Technology (Turkey).
- [Kurt et al.(2000)] Kurt H., Demirbag E. and Kusku I., *Active submarine tectonism and formation of the Gulf of Saros, Northeast Aegean Sea, inferred from multi-channel seismic reflection data*, 2000, Marine Geology, Vol. 165, 13-26.
- [Kuscu et al.(2002)] I. Kusku, M. Okamura, H. Matsuoka, Y. Awata, *Active faults in the Gulf of İzmit on the North Anatolian Fault, NW Turkey: a high-resolution shallow seismic study*, 2002, Marine Geology, 190, 421-443.
- [Le Pichon etc al.(1999)] Le Pichon, X., T. Taymaz, A.M.C. Sengor, *The Marmara Fault and the future Istanbul earthquake*, in: *International Conference on the Kocaeli Earthquake, 17 August 1999*, 1999, Proc., pp. 41-54.
- [Le Pichon et al.(2001)] Le Pichon X., Sengor A.M.C., Demirbag E., Rangin C., Imren C., Armijo R., Gorur N., Cagatay N., de Lepinay B.M., Meyer B., Saatchilar R., Tok B., *The active main Marmara fault*, 2001, Earth and Planetary Sc.Letters, Vol.192, 595-616.
- [Le Pichon et al.(2003)] Le Pichon X., Chamot-Rooke N., Rangin C., Sengor A.M.C., *The North anatolian Fault in the Sea of Marmara*, 2003, J.Geophys.Research[Solid Earth], 108, 2170-2179.
- [Le Pichon et al.(2005)] Le Pichon et al., *MARMARA SURVEY, 11 Sep - 4 oct 2000, Multi-beam Bathymetry, Le Suroit*, 2005. Marine Atlas of the Sea of Marmara, IFREMER, [www.ifremer.fr/drogm\\_uk/marmara](http://www.ifremer.fr/drogm_uk/marmara).
- [Magagnoli A. and Mengoli M. (1995)] A.Magagnoli e M.Mengoli, *CAROTIERE A GRAVITA' SW-104 per carote di sedimento e acqua di fondo di grande diametro e minimo disturbo*, 1995, Rapporto Tecnico IGM N.27.
- [McClusky et al.(2000)] McClusky, S., S. Bassalanian, A. Barka, C. Demir, S. Ergintav, I. Georgiev, O. Gurkan, M. Hamburger, K. Hurst, H.-G. Hans-Gert, K. Karstens, G. Keke lidze, R. King, V. Kotzev, O. Lenk, S. Mahmoud, A. Mishin, M. Nadariya, A. Ouzounis, D. Paradissis, Y. Peter, M. Prilepin, R. Reilinger, I. Sanli, H. Seeger, A. Tealeb, M.N. Toksaz, G. Veis, *Global Positioning system constraints on plate kinematics and dynamics in the eastern Mediterranean and Caucasus*, 2002, Journal of Geophysical Research, 105 (B3), 5695-5719.
- [Meade et al.(2002)] B.J. Meade, B.H. Hager, R.E. Reilinger, *Estimates of seismic potential in the Marmara region from block models of secular deformation constrained by GPS measurements*, 2002, Bulletin of the Seismological Society of America, 92, 208-215.
- [Okay et al.(1999)] Okay, A.I., et al., *Active faults in the Sea of Marmara, western Turkey, imaged by seismic reflection profiles*, 1999, Terra Nova 11, 223-227.
- [Okay et al.(2000)] Okay, A.I., A. Kaslilar-Ozcan, C. Imren, A. Boztepe-Guney, E. Demirbag, I. Kuscu, 2000, *Active faults and evolving strike-slip basins in the Marmara Sea, northwest Turkey: a multichannel seismic reflection study*, Tectonophysics, 321, 189-218.
- [Okay et al.(2004)] Okay, A.I., Tuysuz, O., Kaya, S., *From transpression to transtension: changes in morphology and structure around a bend on the North Anatolian Fault in the Marmara region*, 2004, Tectonophysics, 391, 259-282.

- [Parke et al.(1999)] Parke, J R, Minshull, T A, Anderson, G, White, R S, McKenzie, D, Kucsu, I, Bull, J M, Gorur, N, Sengor, C , *Active faults in the Sea of Marmara, western Turkey, imaged by seismic reflection profiles*, Terra Nova, vol.11, no.5, pp.223-227.
- [Parke et al.(2002)] J.R. Parke, R.S. White, D. McKenzie, T.A. Minshull, J.M. Bull, I. Kucsu, N. Gorur, C. Sengor, *Interaction between faulting and sedimentation in the Sea of Marmara, western Turkey*, 2002, Journal of Geophysical Research-Solid Earth, 107, art. no.-2286.
- [Parsons et al.(2000)] Parsons, T.S, Toda T.S., Stein R.S., Barka A., Dietrich J.H., *Heightened odds of large earthquakes near Istanbul, An interaction-based probability calculation*, 2000, Science, 288, 661-665.
- [Polonia et al.(2002)] Polonia, A., M.H. Cormier, M.N. Cagatay, G. Bortoluzzi, E. Bonatti, L. Gasperini, M. Ligi, L. Capotondi, L. Seeber, C.M.G. McHugh, W.B.F. Ryan, N. Gorur, O. Emre, B. Tok, and the MARMARA2000 and MARMARA2001 scientific parties, *Exploring submarine earthquake geology in the Marmara Sea*, 2002, EOS Trans. Am. Geophys. U., 82, 229 and 235-235.
- [Polonia et al.(2004)] Polonia A., Gasperini L., Amorosi A., Bonatti E., Bortoluzzi G., Cagatay N., Capotondi L., Cormier M.H., Gorur N., McHigh C. and Seeber L., *Holocene slip rate of the Northern Anatolian Fault beneath the Sea of Marmara*, 2004, Earth and Planet.Sc. Letters, Vol.227, 3-4, 411-426.
- [Povost et al.(2003)] A.S. Provost, J. Chery, R. Hassani, *3D mechanical modeling of the GPS velocity field along the North Anatolian fault*, 2003, Earth and Planetary Science Letters, 209, 361-377.
- [Reilinger and McClusky (2000)] Reilinger, R., McClusky, S., *GPS constraints on present-day plate motions and deformation in the Eastern Mediterranean/Caucasus region*, 2000, AGU 2000 fall meeting, Eos, Transactions, American Geophysical Union, vol.81, no.48, Suppl., pp.1222.
- [Reilinger et al.(2000)] R. E. Reilinger, S. Ergintav, R. Burgmann, S. McClusky, O. Lenk, A. Barka, O. Gurkan, L. Hearn, K. L. Feigl, R. Cakmak, B. Aktug, H. Ozener, M. N. Toksoz, *Coseismic and Postseismic Fault Slip for the 17 August 1999, M=7.5, İzmit, Turkey Earthquake*, 2000, Science, Vol 289, Issue 5484, 1519-1524. URL: [www.sciencemag.org/cgi/content/full/289/5484/1519](http://www.sciencemag.org/cgi/content/full/289/5484/1519).
- [Rockwell et al.(2001)] Rockwell, T., A. Barka,, T. Dawson, K. Thorup, and S. Akyuz, *Paleoseismology of the Gazikoy-Saros segment of the North Anatolia fault, northwestern Turkey: Comparison of the historical and paleoseismic records, implications of regional seismic hazard, and models of earthquake recurrence*, 2001, International Journal of Seismology, June, 2001 issue.
- [Sandwell and Smith(2001)] URL: [topex.ucsd.edu/marine\\_topo/text/topo.html](http://topex.ucsd.edu/marine_topo/text/topo.html)
- [Seeber et al.(2004)] L. Seeber, O. Emre, M.H. Cormier, C.C. Sorlien, C.M.G. McHugh, A. Polonia, N. Ozer, N. Cagatay and The team of the 2001 R/V Urania Cruise in the Marmara Sea, *Uplift and subsidence from oblique slip: the Ganos Marmara bend of the North Anatolian Transform, western Turkey*, 2004, Tectonophysics, Volume 391, 1-4, 239-258
- [Sengor (1979)] Sengor A.M.C., *The North Anatolian transform fault: its age, offset and tectonic significance*, 1979, J. Geol. Soc. London, 136, 269-282.
- [Sengor et al.(1985)] Sengor A.M.C., Gorur N., Saroglu F., *Strike-slip faulting and related basin formation in zones of tectonic escape: Turkey as a case study*, 1985, In: Biddle K.D., Christie-Blick N. (eds.) Strike-slip deformation, basin formation, and sedimentation. SEPM Spec. Publ.17, 227-264.

- [Sengor et al.(2004)] Sengor, A.M.C., Tuysuz, O., Imren, C., Sakinc, M., Eyidogan, H., Gorur, N., Le Pichon, X., Claude Rangin, C., *The North Anatolian Fault. A new look*, 2004, Ann. Rev. Earth Planet. Sci. 33, 1-75.
- [Shindler (1997)] C.Shindler, *Geology of NW Turkey: Results of the Marmara poly-project*, 1997, in Active Tectonics of Northwestern Anatolia: The Marmara Project, edited by C. Shindler and M. Pfister, Verlag der Fachvereine, Zurich.
- [Stein et al.(1997)] R.S. Stein, A. Barka, J.H. Dieterich, *Progressive failure on the North Anatolian Fault since 1989 by earthquake stress triggering*, 1997, Geophysical Journal International, 128, 594-604.
- [Taviani et al. (2008)] Taviani M., Angeletti L., Cagatay N., Gasperini L., Polonia A., Wesslingh F. (2008). *Flooding Of The Late Pleistocene Gemlik Caspian-Like Water Body (Marmara Sea) As Documented By Macrofaunal Data*. In: International Geological Congress, Abstracts Congres Geologique International, Resumes. 33rd international geological congress,. Oslo, Norway. Aug. 6-14, 2008. (vol. 33).
- [Tuysuz et al.(1998)] Tuysuz O., Barka A. and Yigitbas E., *Geology of the Saros graben and its implications for the evolution of the North Anatolian fault in the Ganos-Saros region, northwestern Turkey*, 1998, Tectonophysics, Vol.293, 105-126.
- [USGS(2000)] USGS, Holzer et al., *Implications for Earthquake Risk Reduction in the United States from the Kocaeli, Turkey, Earthquake of August 17, 1999*, 2000, U.S. Geological Survey, U.S. Geological Survey Circular 1193. [USR:pubs.usgs.gov/circ/2000/c1193/](http://pubs.usgs.gov/circ/2000/c1193/).
- [Wessel and Smith (1995)] Wessel P. and Smith W.H.F., *New version of the Generic Mapping Tool released*, EOS Trans. AGU, p.329, 1995, see also URL: [gmt.soest.hawaii.edu](http://gmt.soest.hawaii.edu).
- [Wong et al.(1995)] H.K. Wong, T. Ludmann, A. Ulug, N. Gorur, *The Sea of Marmara: A plate boundary sea in an escape tectonic regime*, 1995, Tectonophysics 244 (1995) 231-250.
- [Yaltirak et al.(2000)] Yaltirak C., Sakinc M., Oktay F.Y., *Westward propagation of the North Anatolian fault into the northern Aegean: timing and kinematics- Comment and reply*, 2000, Geology, 28, 187-189.



## 6 APPENDIX

### 6.1 DIARY OF OPERATIONS

- 2009-09-22 In Brindisi, mobilization and installation of IFREMER (piezometer frame) and INGV equipment on pier.
- 2009-09-23 Work in Brindisi, installation and test Medusa and SN-4. Left port 12:00 local time, sailing to Corinth and Çannakale. Start launch XBT 15:55 UTC.
- 2009-09-24 Test installation equipment. Continue to launch XBT. Transit Corinth Strait 15:30 UTC.
- 2009-09-25 Test installation equipment. Continue to launch XBT. Berthed in Çannakale 11:30 UTC.
- 2009-09-26 Embarkation French and Turkish scientific crew. Test of deployment of piezometer. 17:00 UTC sailing to Dardanelles and Sea of Marmara.
- 2009-09-27 CHIRP, MBES and ADCP acquisition. OBS 01..07 at sea, Piezometer and Cores.
- 2009-09-28 CHIRP, MBES and ADCP acquisition. OBS 08..10 at sea, Piezometer and Cores.
- 2009-09-29 CHIRP, MBES and ADCP acquisition. Box corer, gravity cores, positioning of 2 piezometer and OBS
- 2009-09-30 CHIRP Multibeam in Büyükçekmece, at 05:30 UTC in anchor. Crew change, disembark IFREMER team, embark INGV team. At 18:00 UTC leave anchorage and sail to Çınarcık area.
- 2009-10-01 CHIRP, MBES and ADCP acquisition. Mapping Darica canyon. MEDUSA deployment. Mapping Karamürsel basin.
- 2009-10-02 CHIRP, MBES and ADCP acquisition. Mapping in Karamürsel. 06:00 UTC entering Golciuk for mapping NAF and Northern flanks of Gulf. 09:00 UTC heading to SN-4 site. MEDUSA investigations from 11:40 (on bottom) to 16:00 UTC (on board). Continuing mapping on Karamürsel.
- 2009-10-03 CHIRP, MBES and ADCP acquisition. Box corer, gravity cores on SN4 point.
- 2009-10-04 CHIRP, MBES and ADCP acquisition. Deployment of SN4 station.
- 2009-10-05 CHIRP, MBES and ADCP acquisition. Control SN4 station with Medusa.
- 2009-10-06 CHIRP, MBES and ADCP acquisition. Gravity cores and SW104 cores.
- 2009-10-07 CHIRP, MBES and ADCP acquisition. H.16:00 (local time) end of operation, sailing to Istanbul to disembark scientists.
- 2009-10-08 Istanbul: H.7:30 (local time) disembark. H19:30(local time) sailing to Messina.
- 2009-10-09 Sailing to Messina, CHIRP, MBES, ADCP acquisition and XBT launch.
- 2009-10-10 Sailing to Messina, CHIRP, MBES, ADCP acquisition and XBT launch.
- 2009-10-11 Sailing to Messina, CHIRP, MBES, ADCP acquisition. 18:30 local berthed in Messina.
- 2009-10-12 Disembark on Messina.

## 6.2 POSITIONING MAPS OF MOST RELEVANT OPERATIONS AT SEA

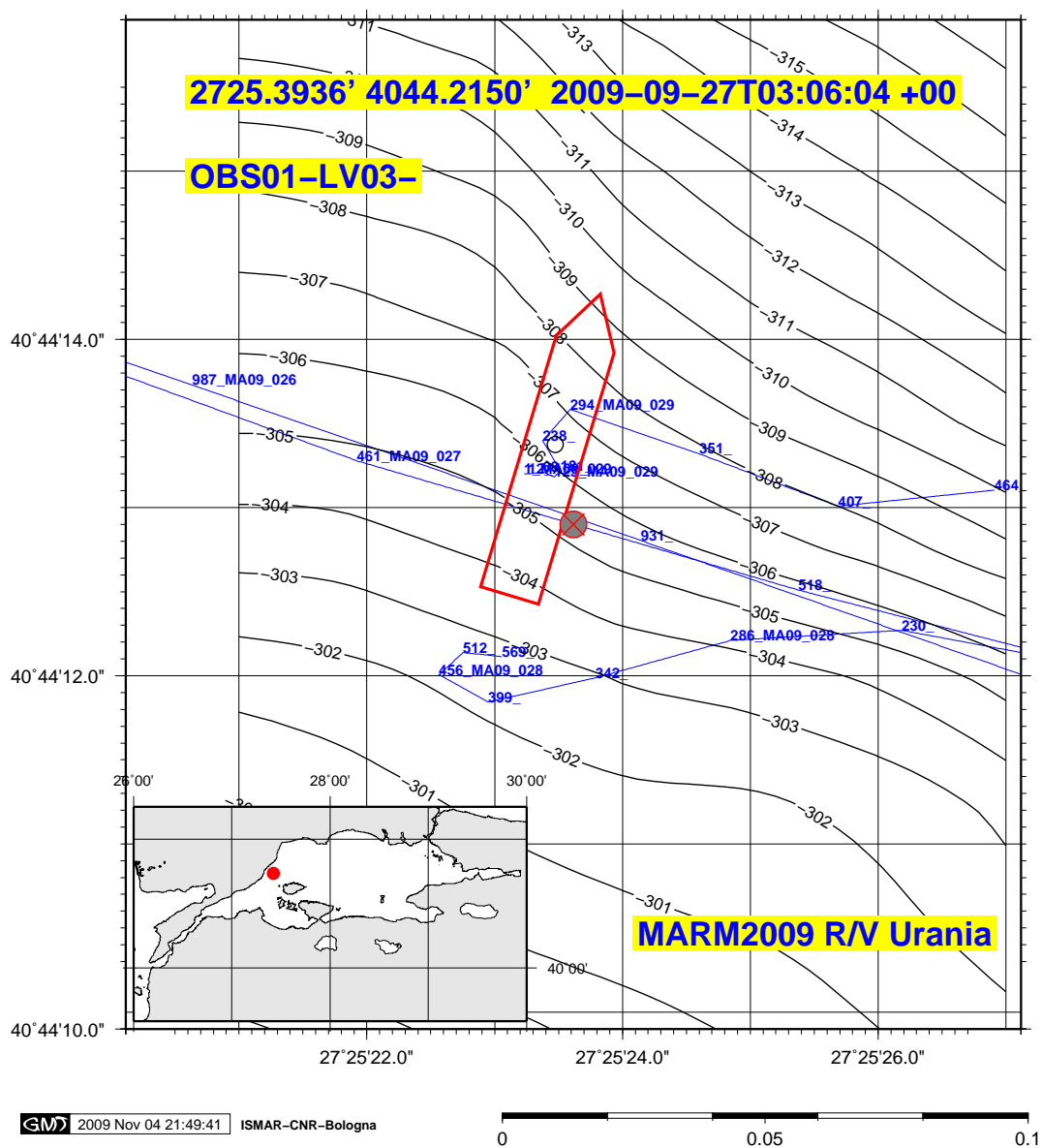

Figure 36: OBS01-LV03- positioning data.

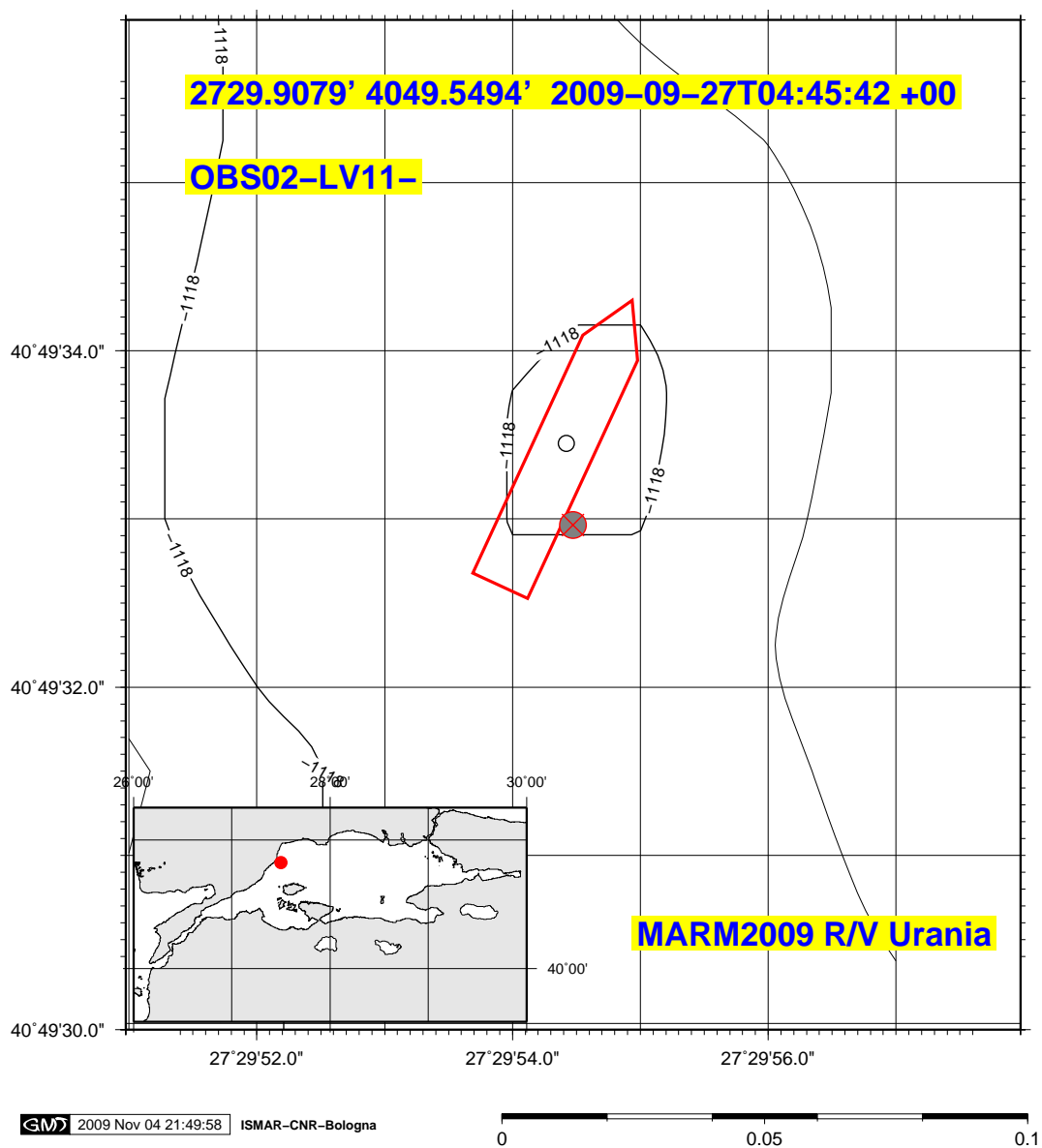

Figure 37: OBS02-LV11- positioning data.

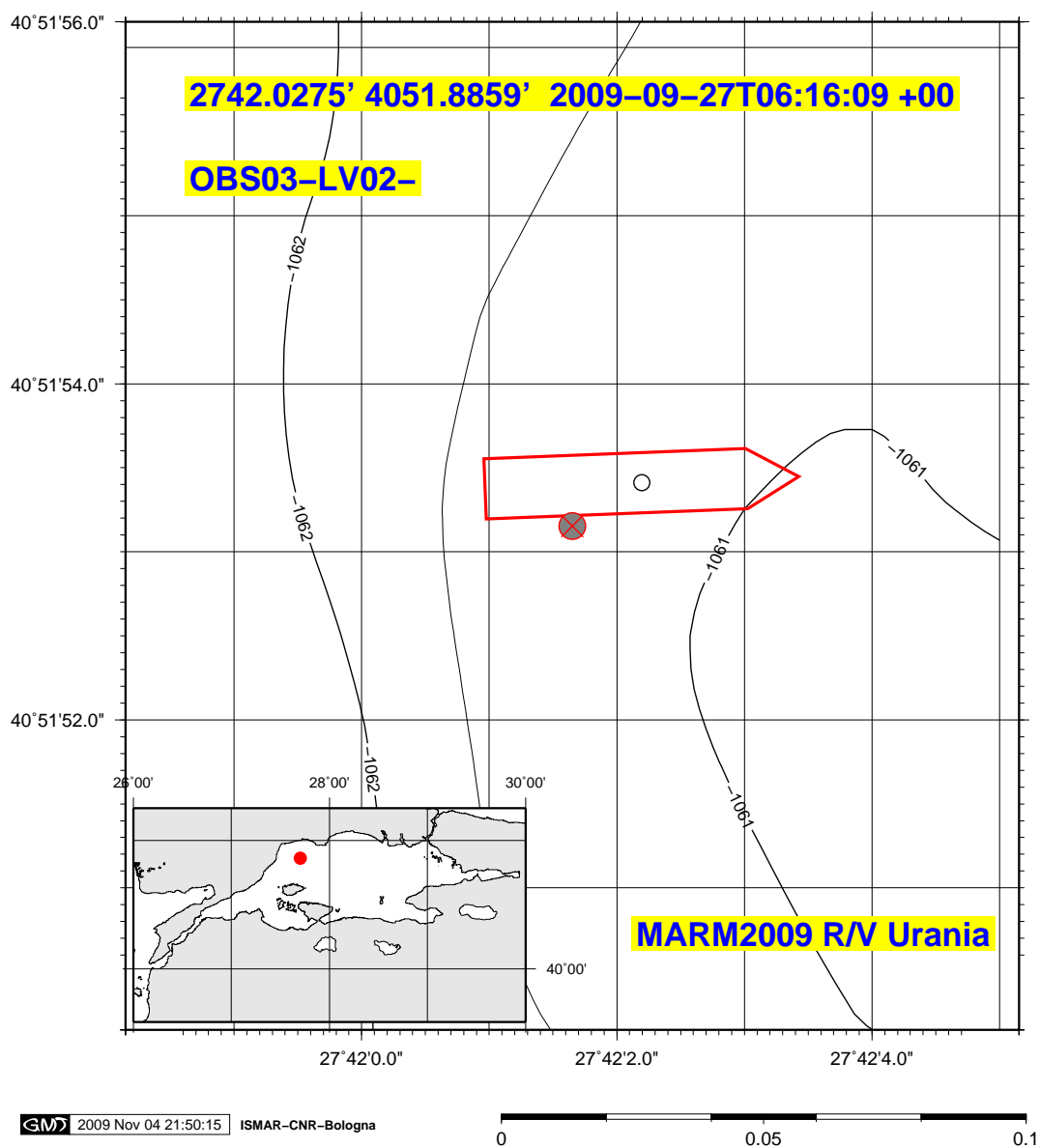

Figure 38: OBS03-LV02- positioning data.

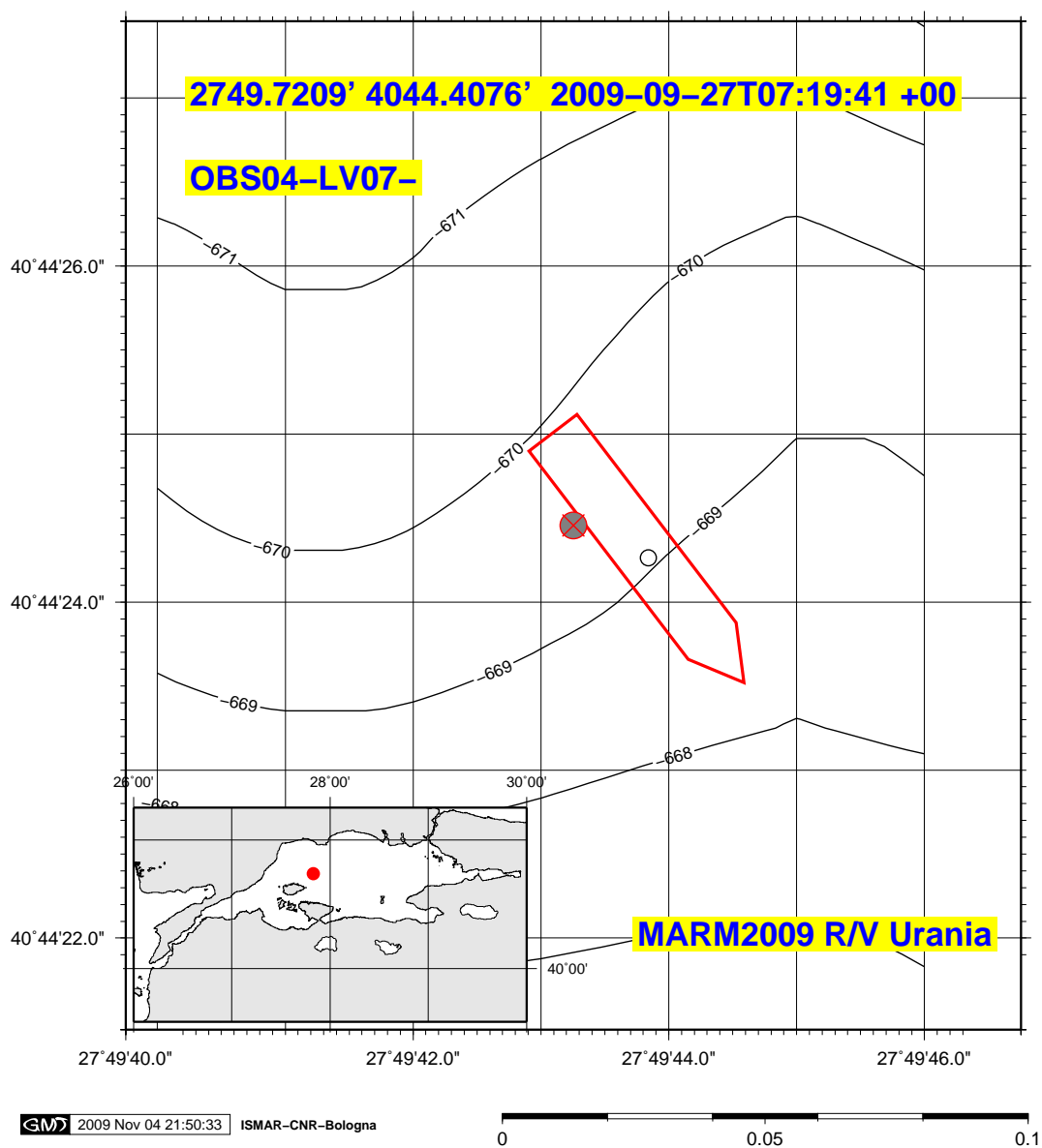

Figure 39: OBS04-LV07- positioning data.



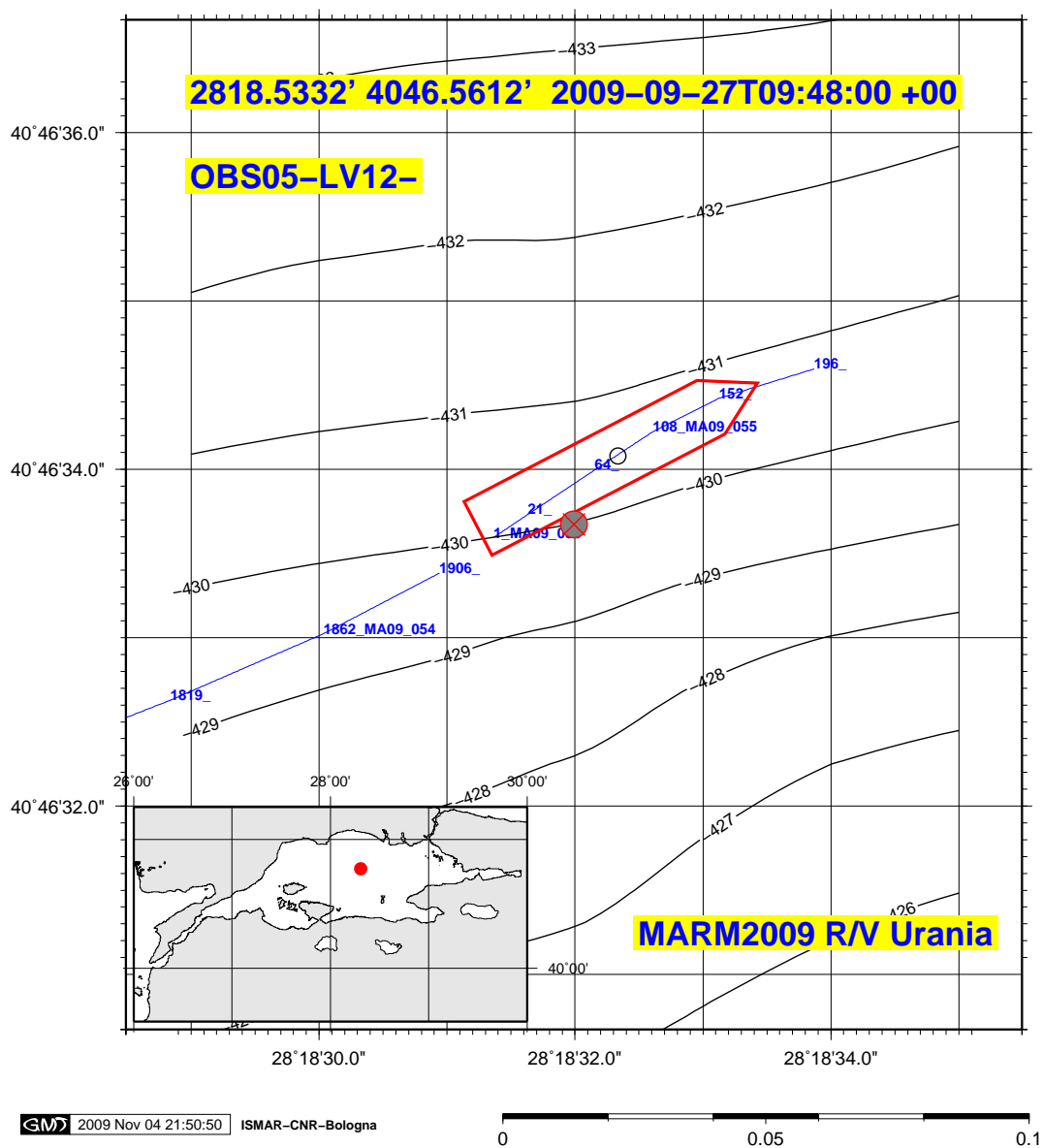

Figure 40: OBS05-LV12- positioning data.



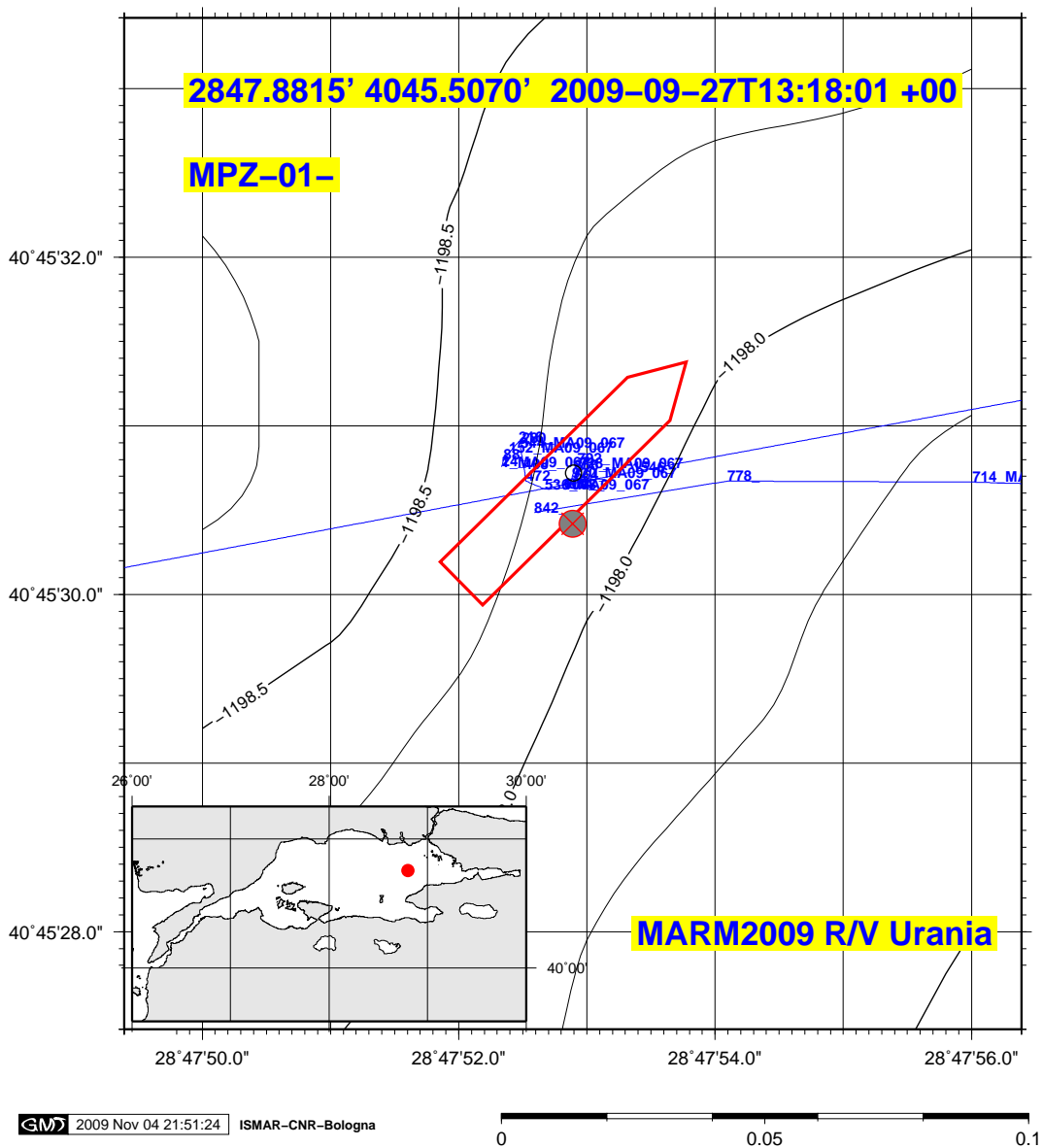

Figure 42: MPZ-01- positioning data.

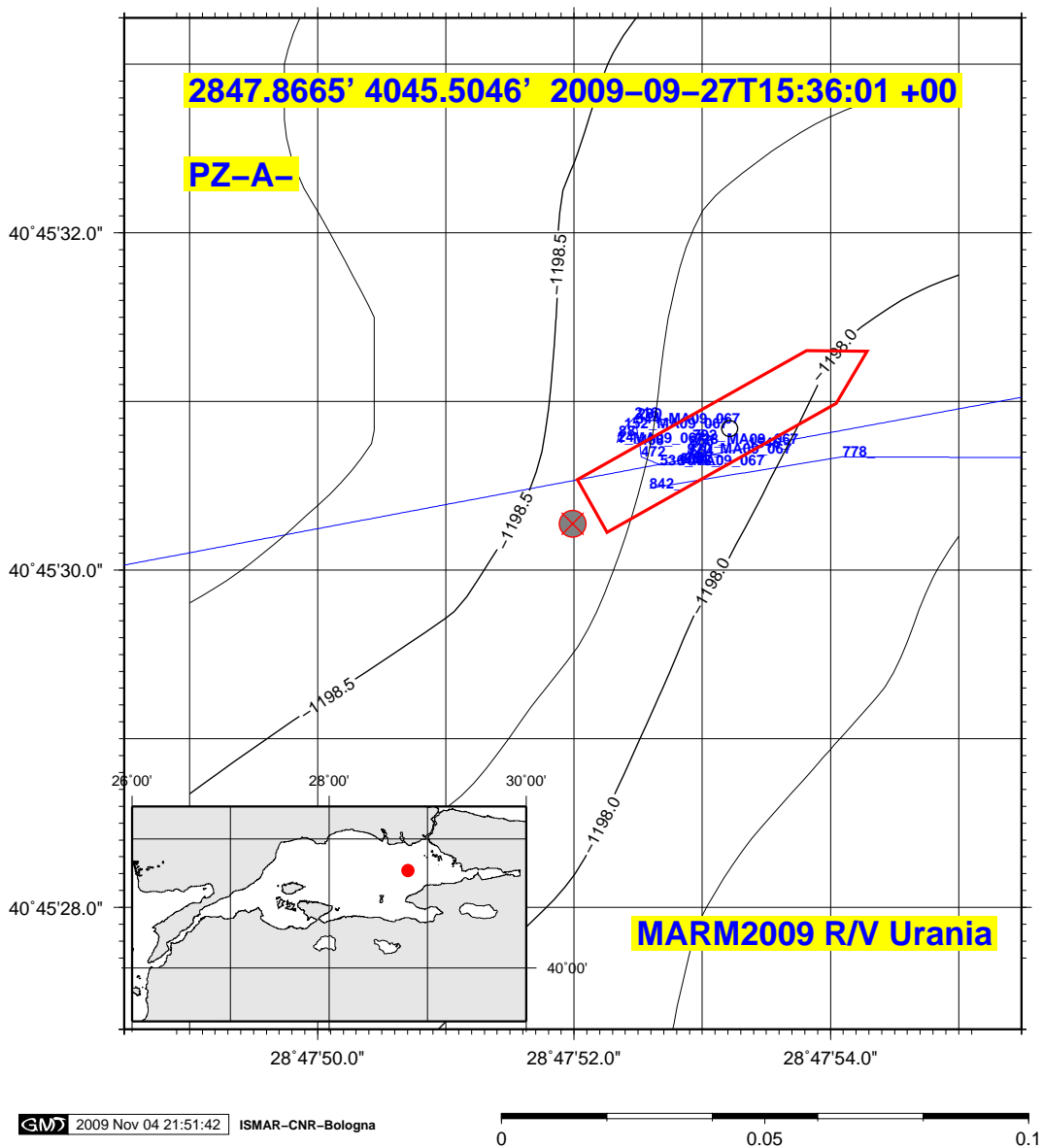

Figure 43: PZ-A- positioning data.





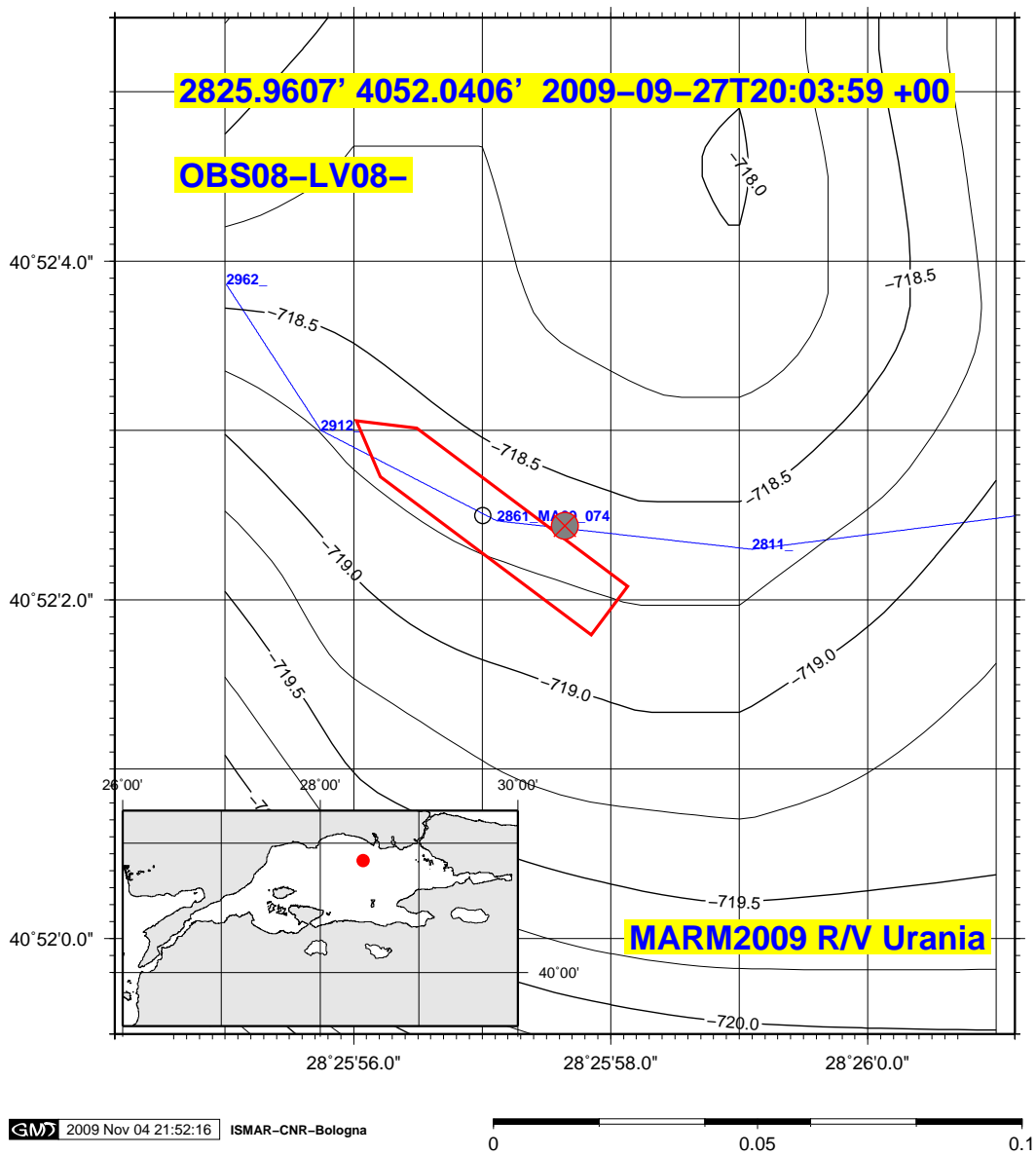

Figure 45: OBS08-LV08- positioning data.

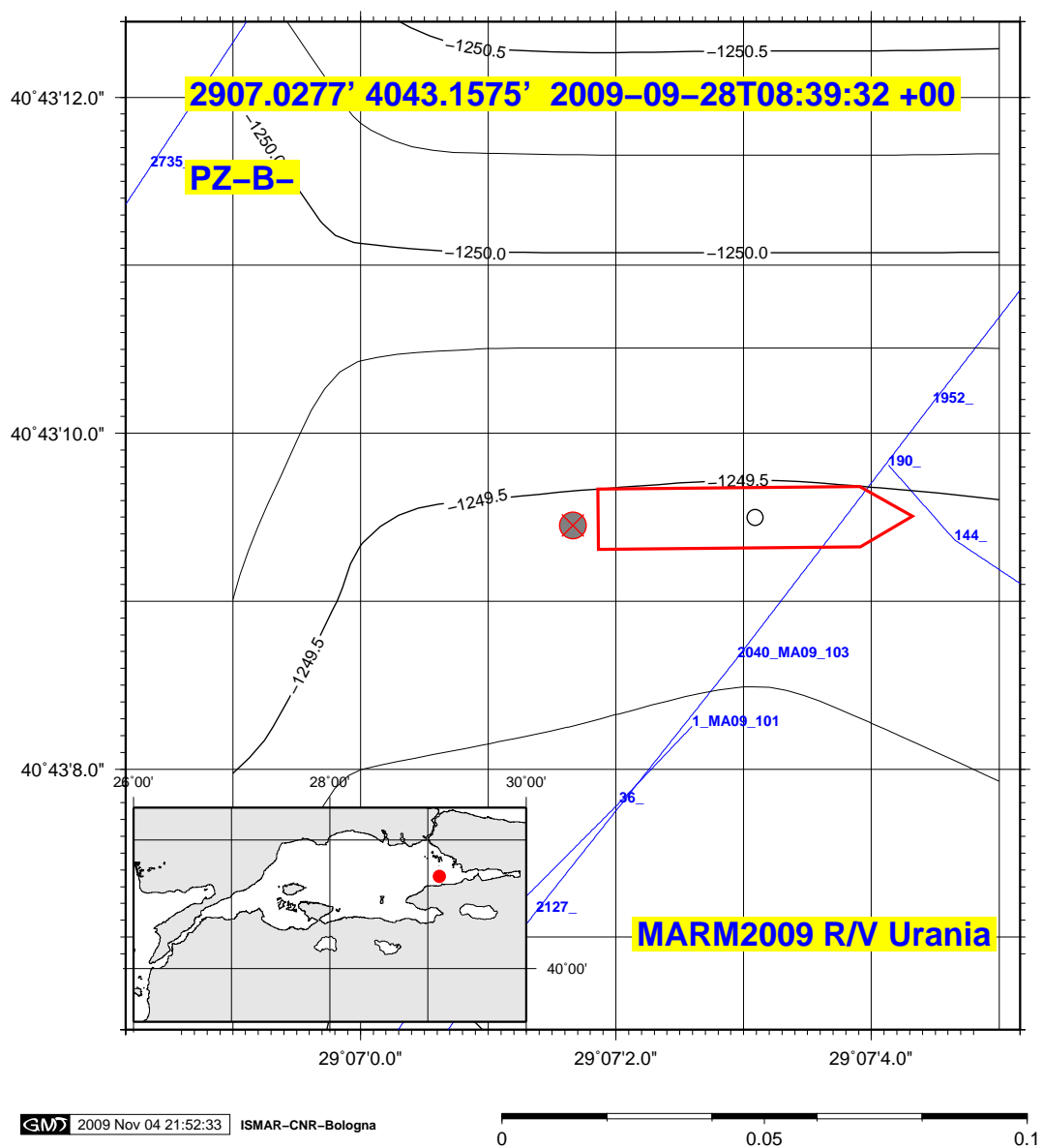

Figure 46: PZ-B- positioning data.

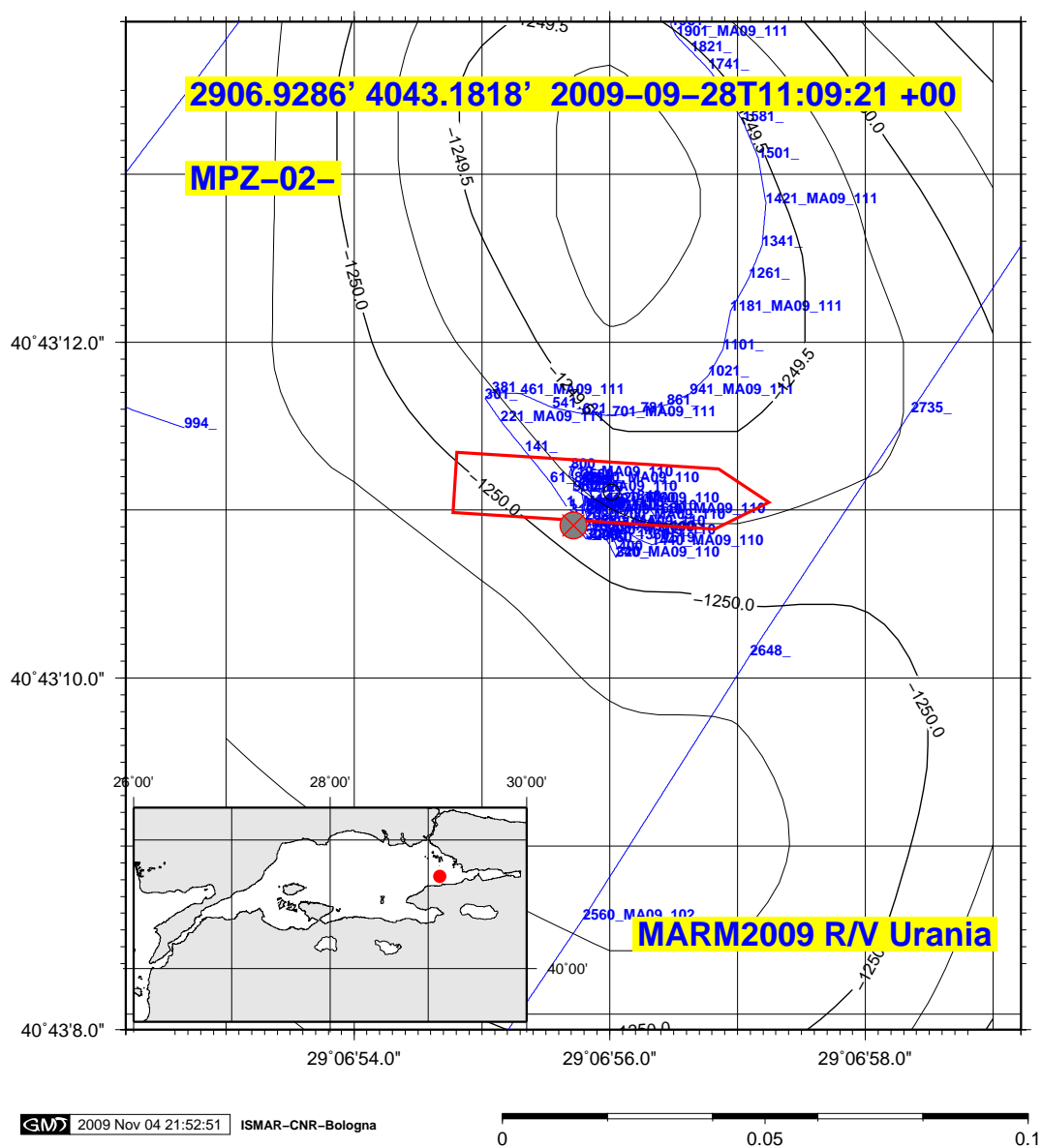

Figure 47: MPZ-02- positioning data.

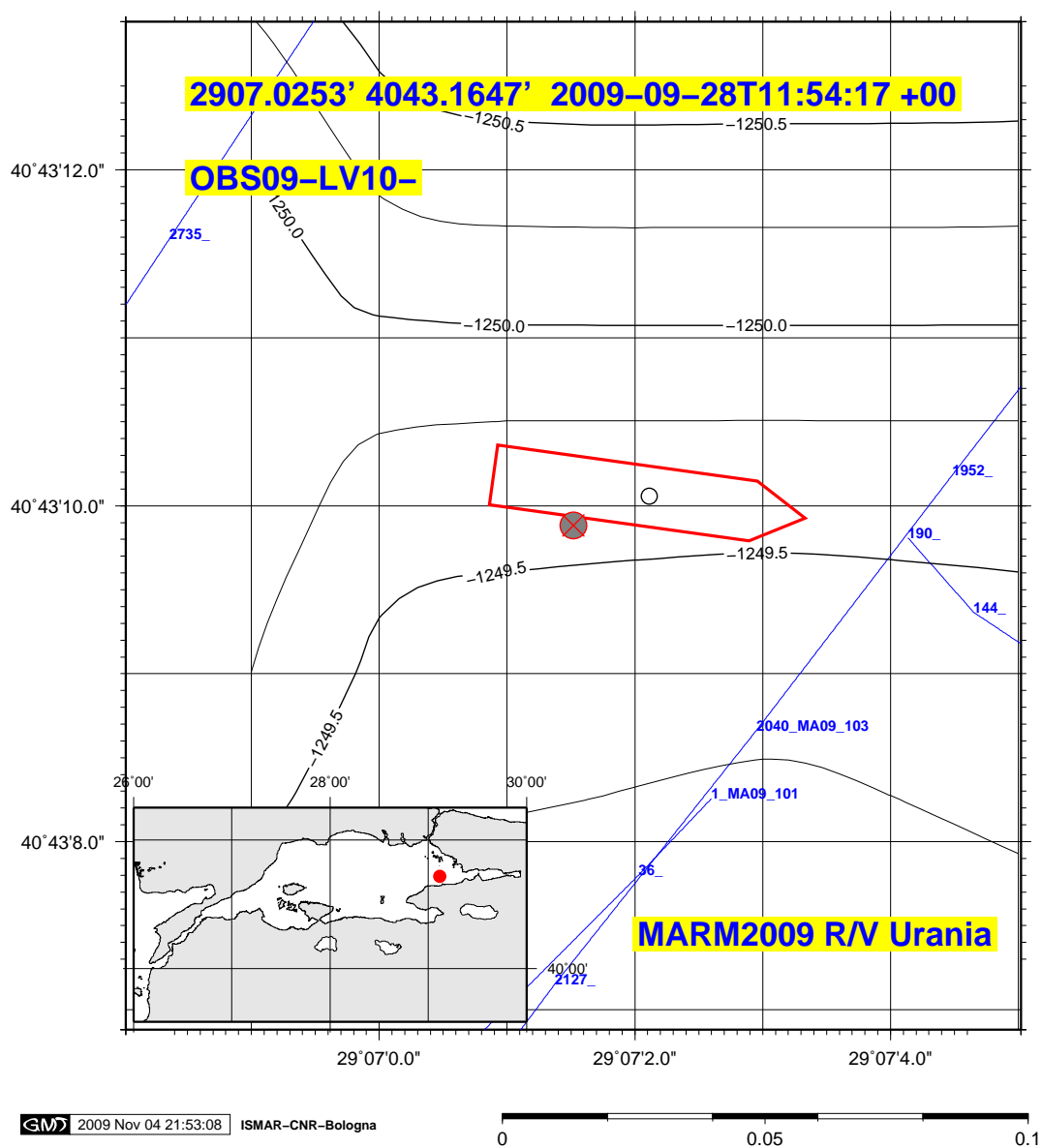

Figure 48: OBS09-LV10- positioning data.

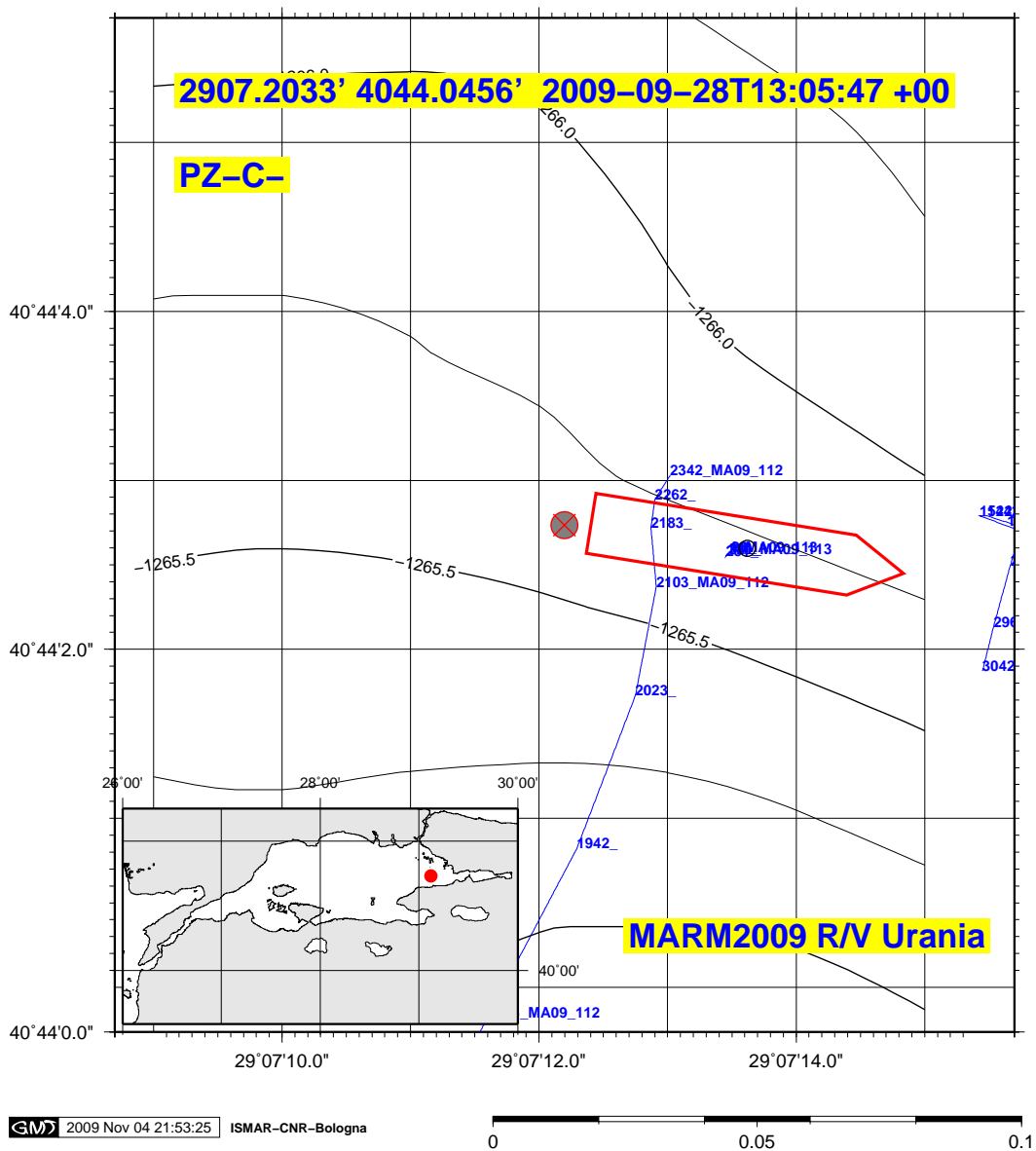

Figure 49: PZ-C- positioning data.



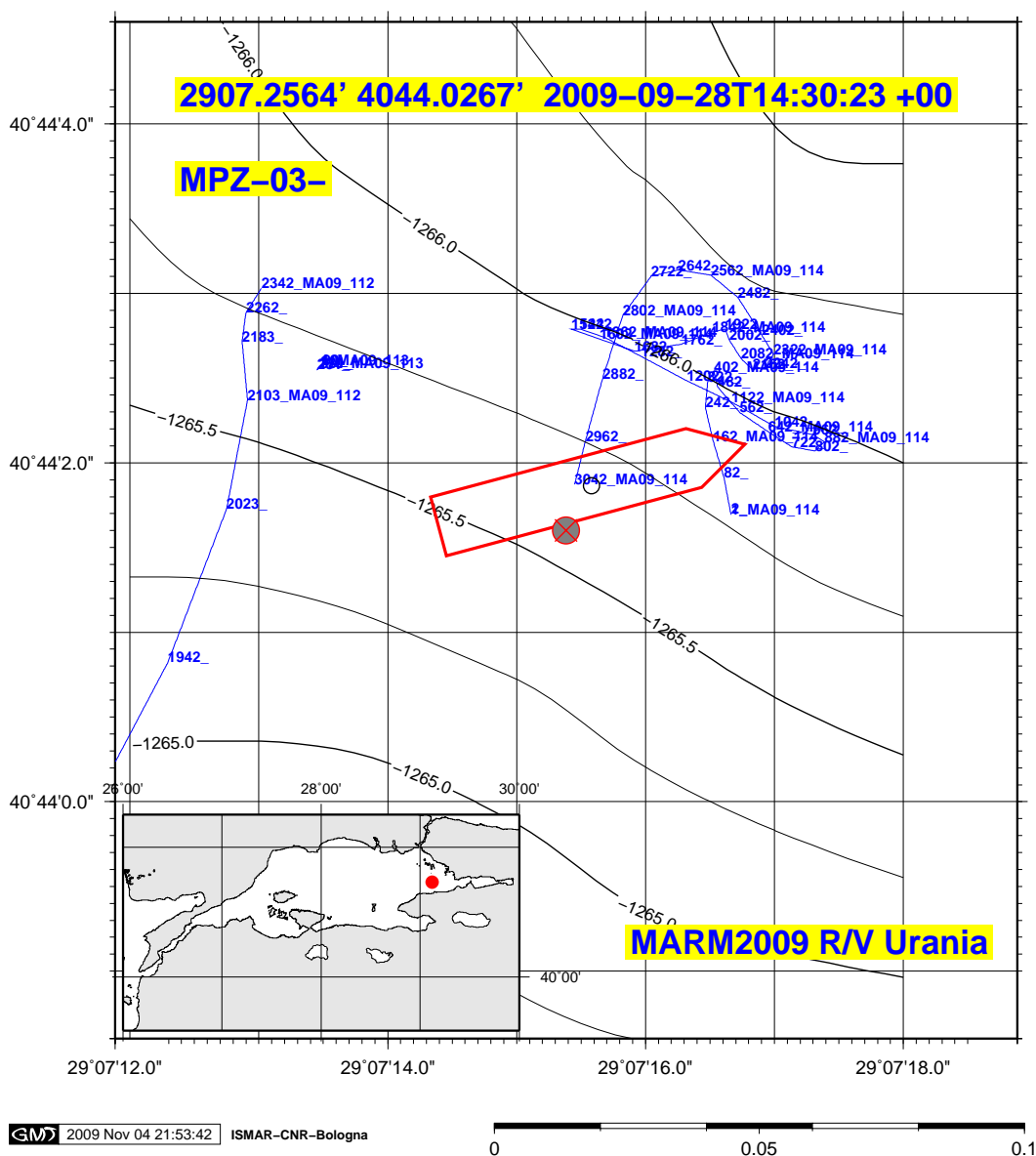

Figure 50: MPZ-03- positioning data.



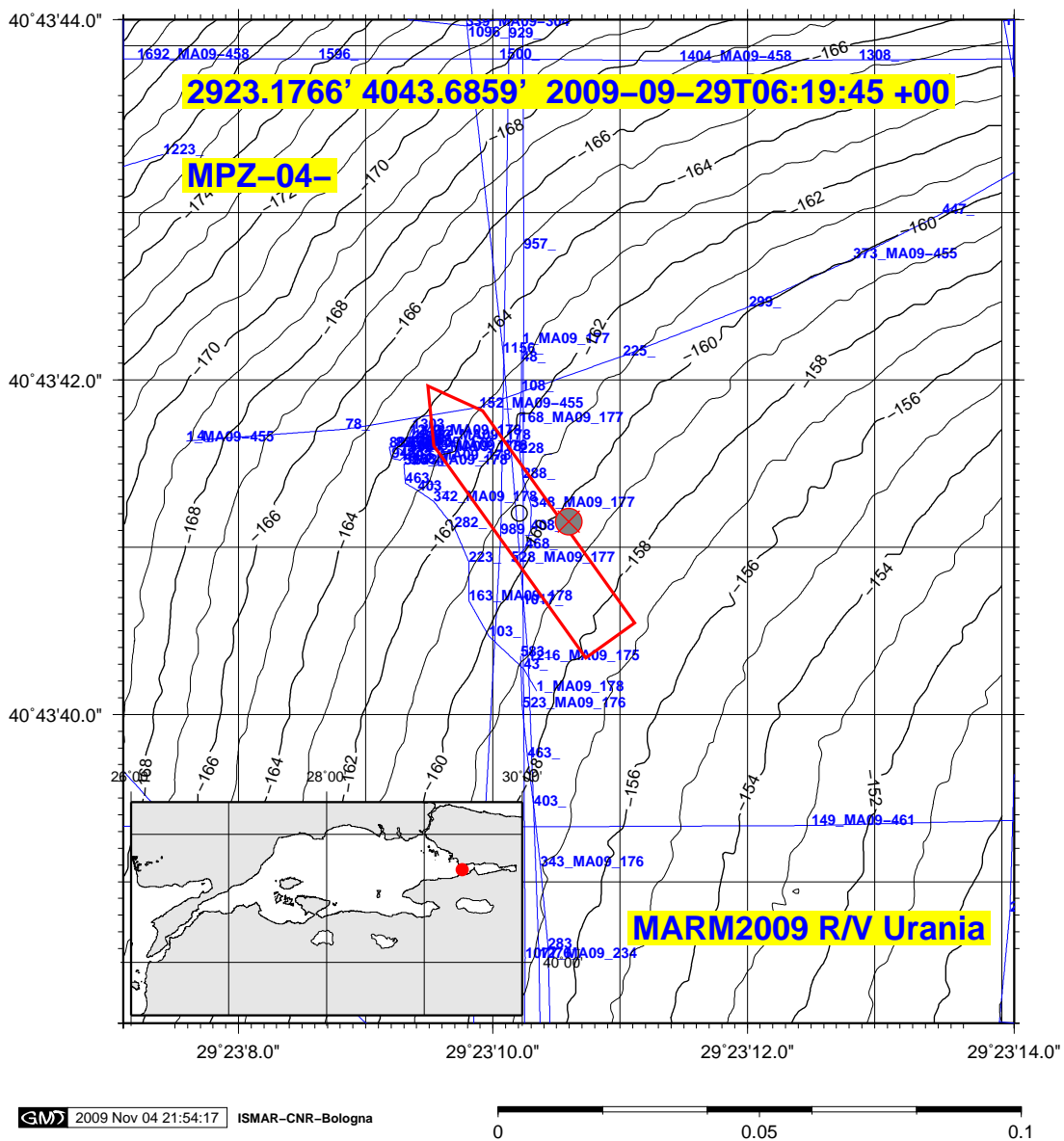

Figure 52: MPZ-04- positioning data.



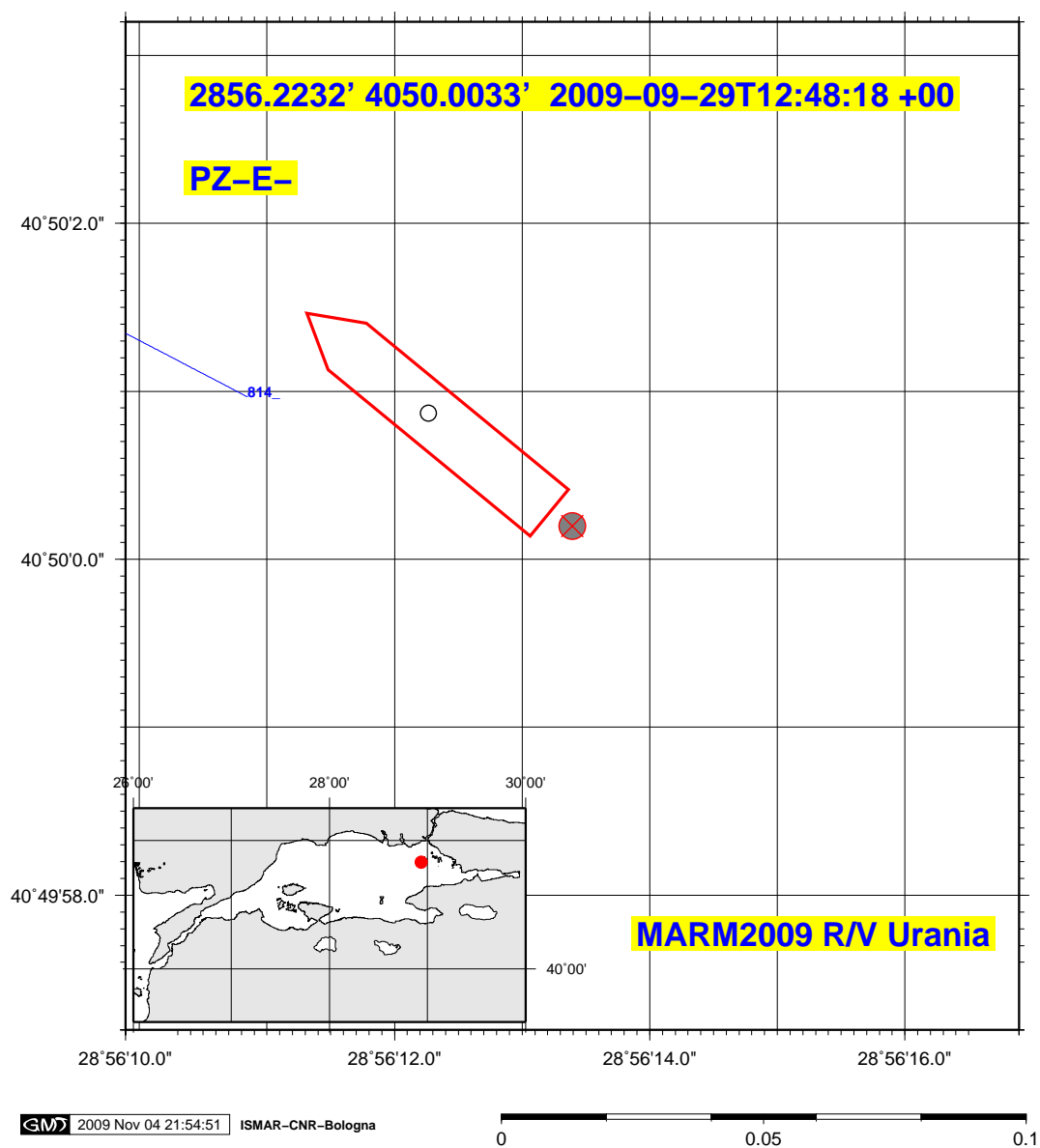

Figure 54: PZ-E- positioning data.



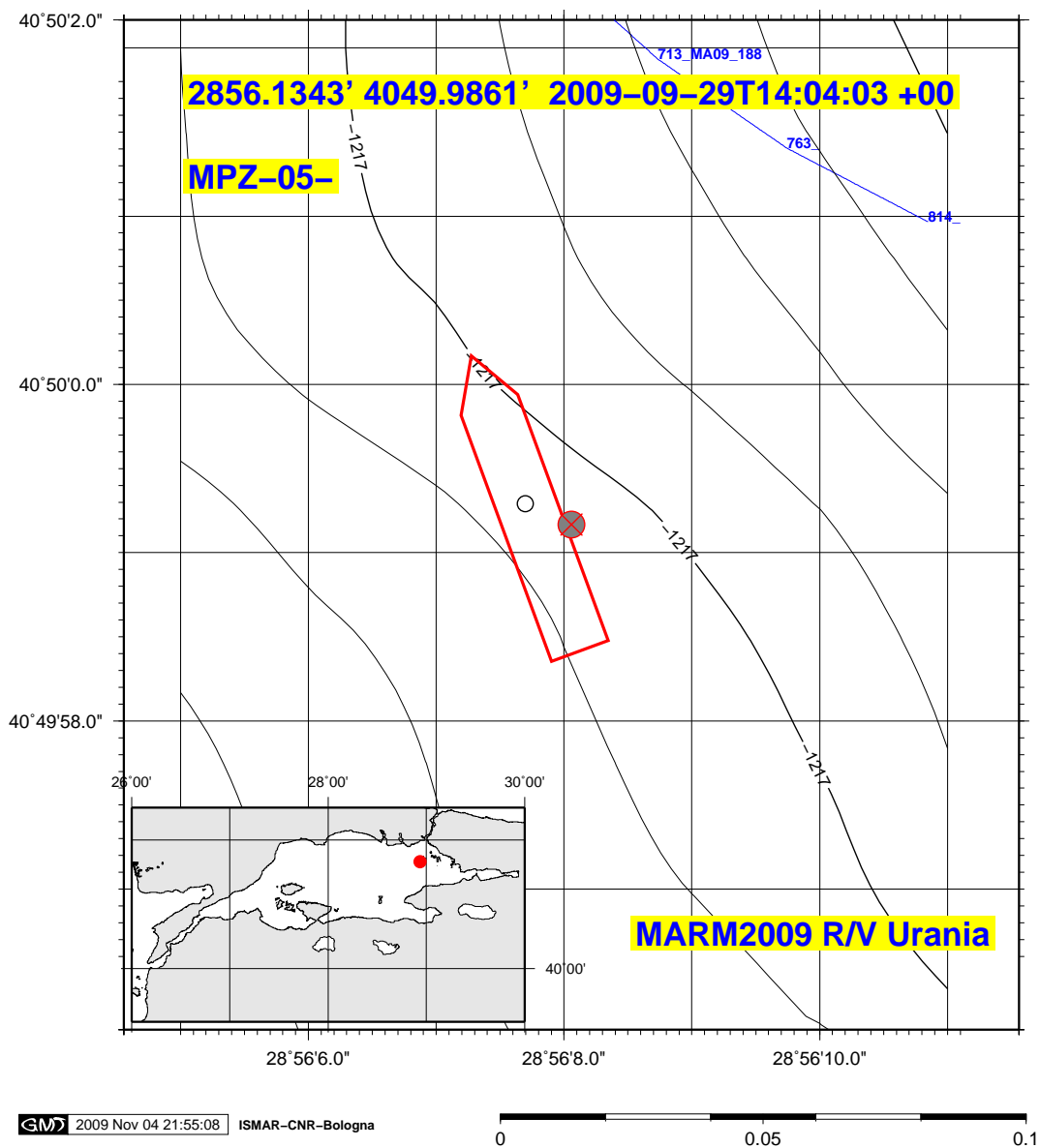

Figure 55: MPZ-05- positioning data.

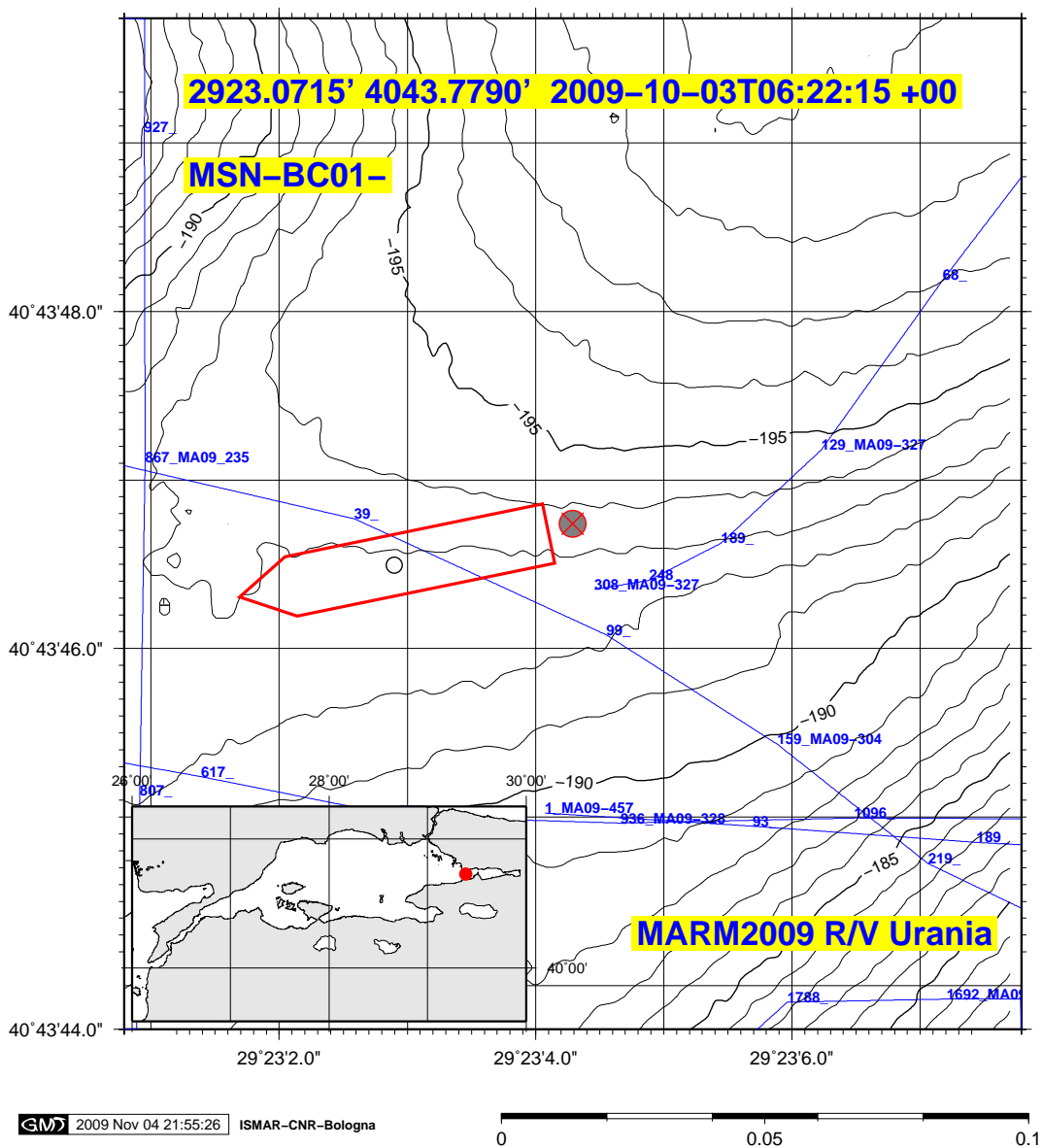

Figure 56: MSN-BC01- positioning data.

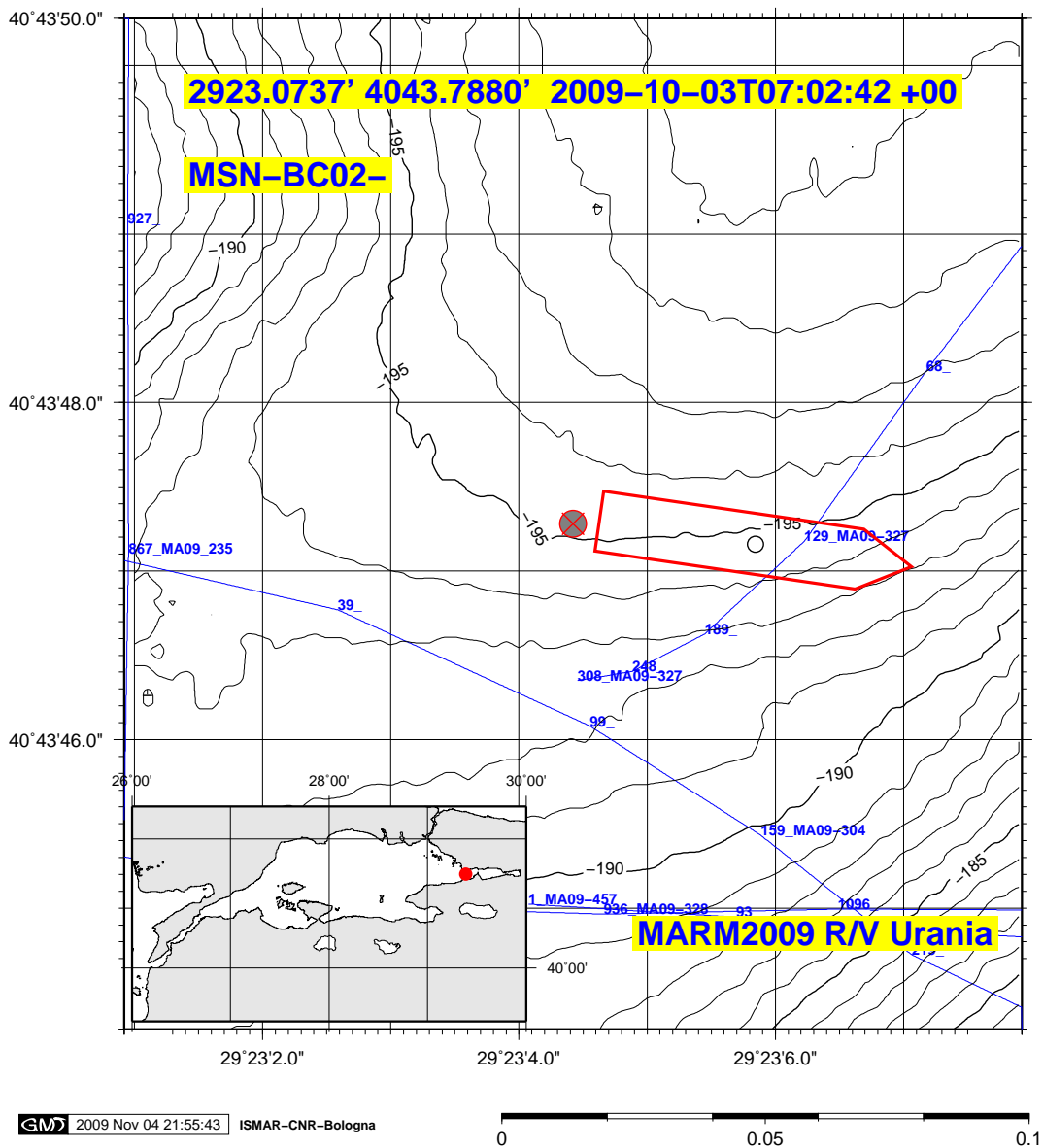

Figure 57: MSN-BC02- positioning data.

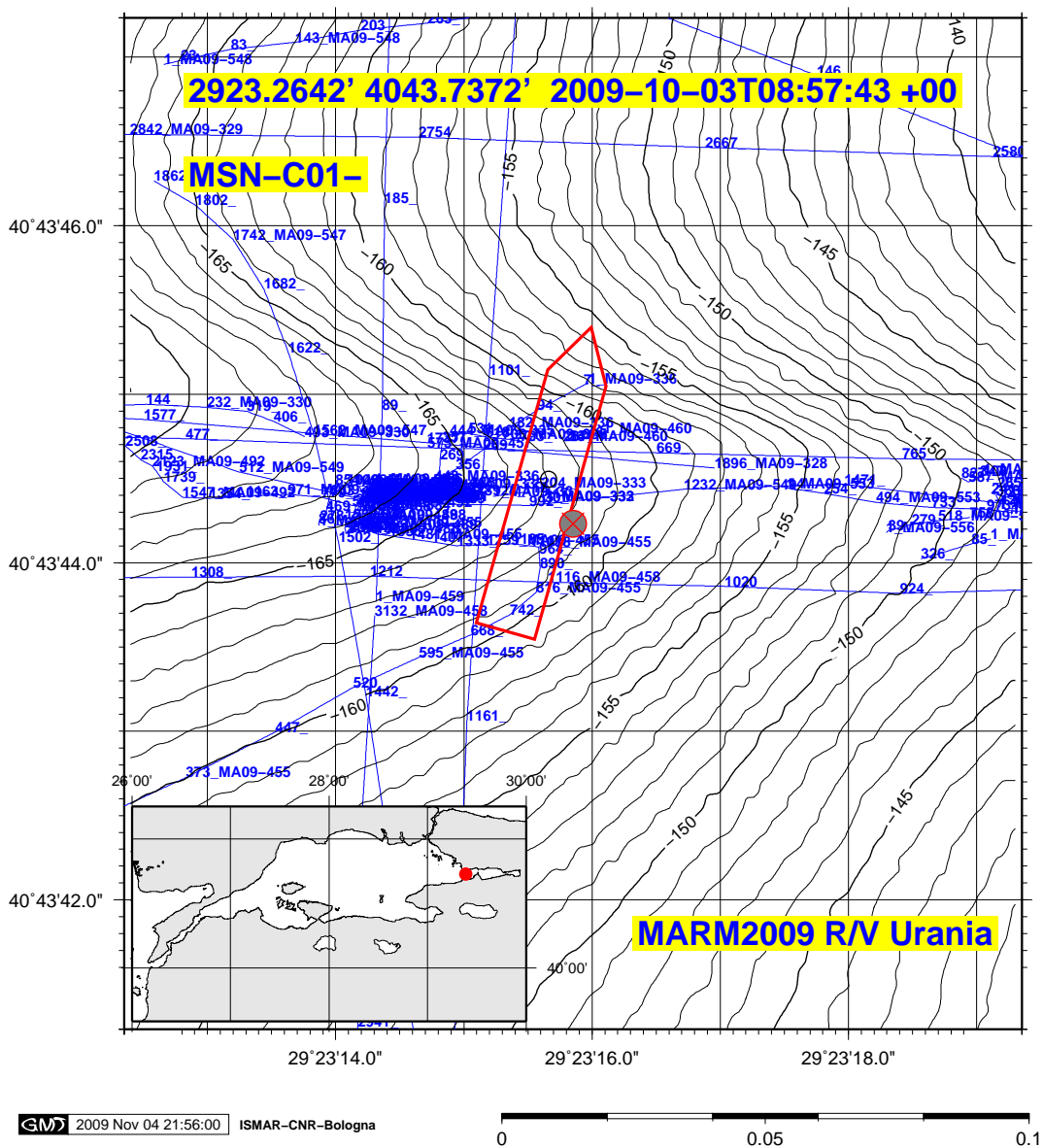

Figure 58: MSN-C01- positioning data.

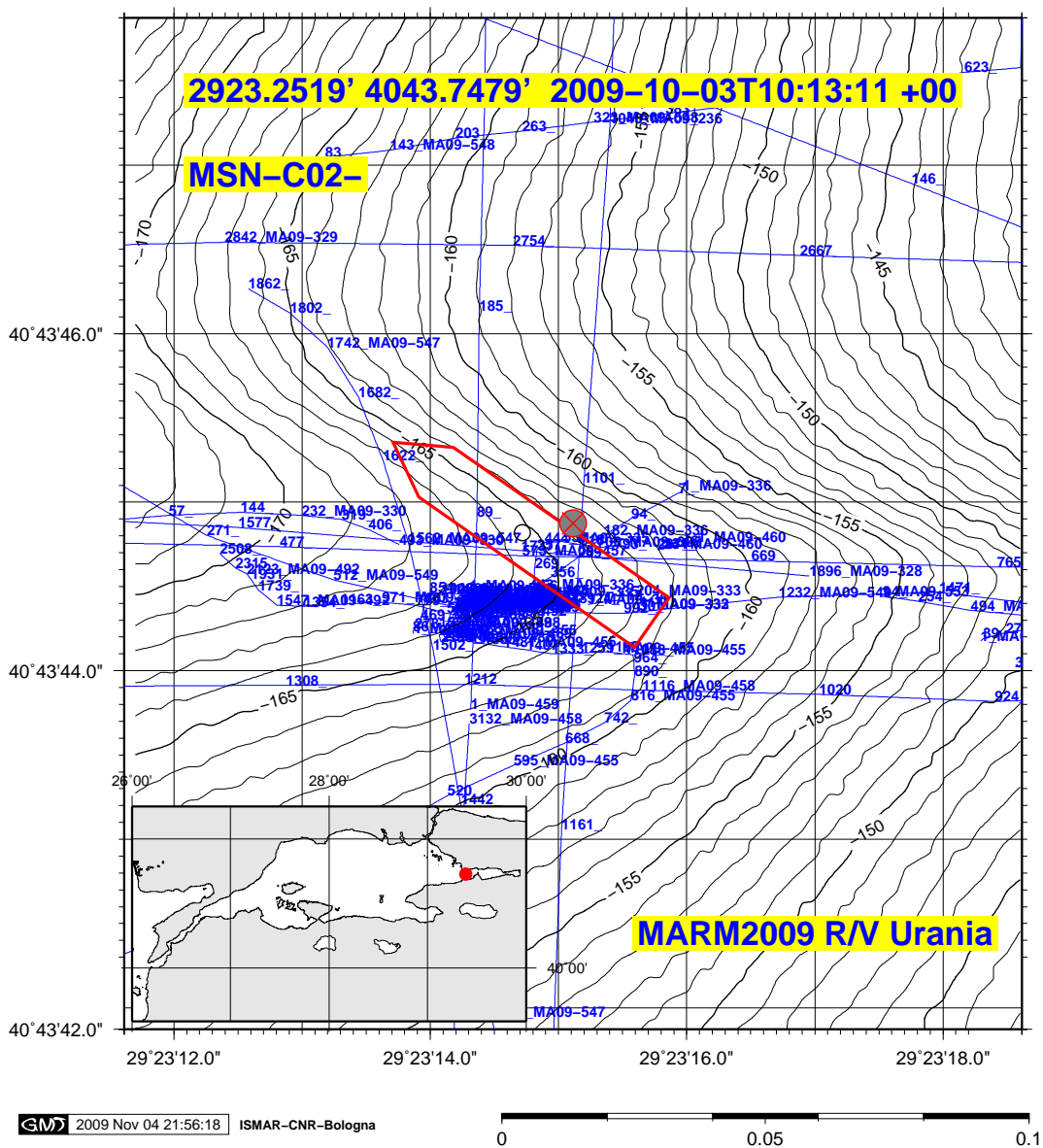

Figure 59: MSN-C02- positioning data.

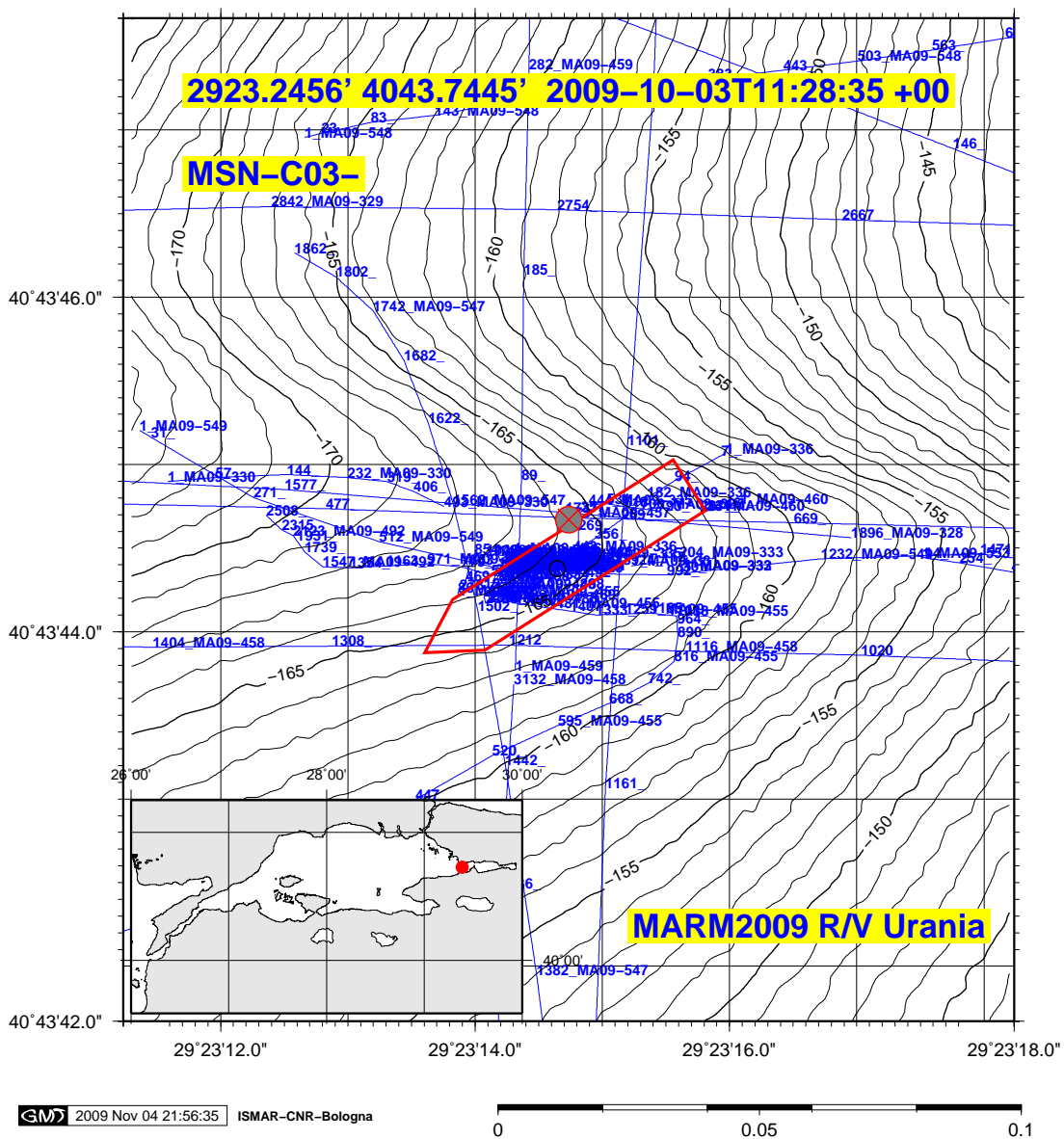

Figure 60: MSN-C03- positioning data.



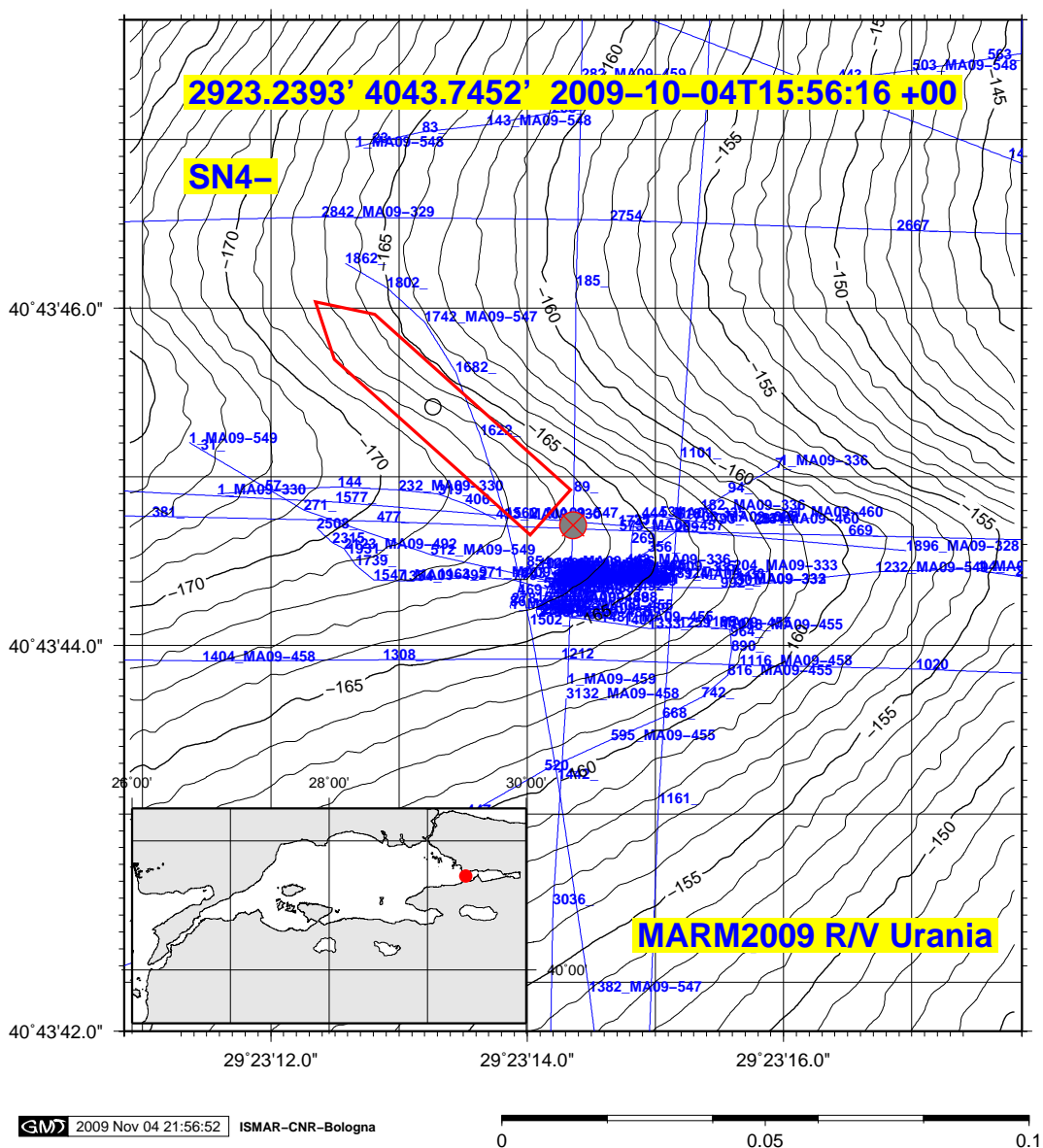

Figure 61: SN4- positioning data.

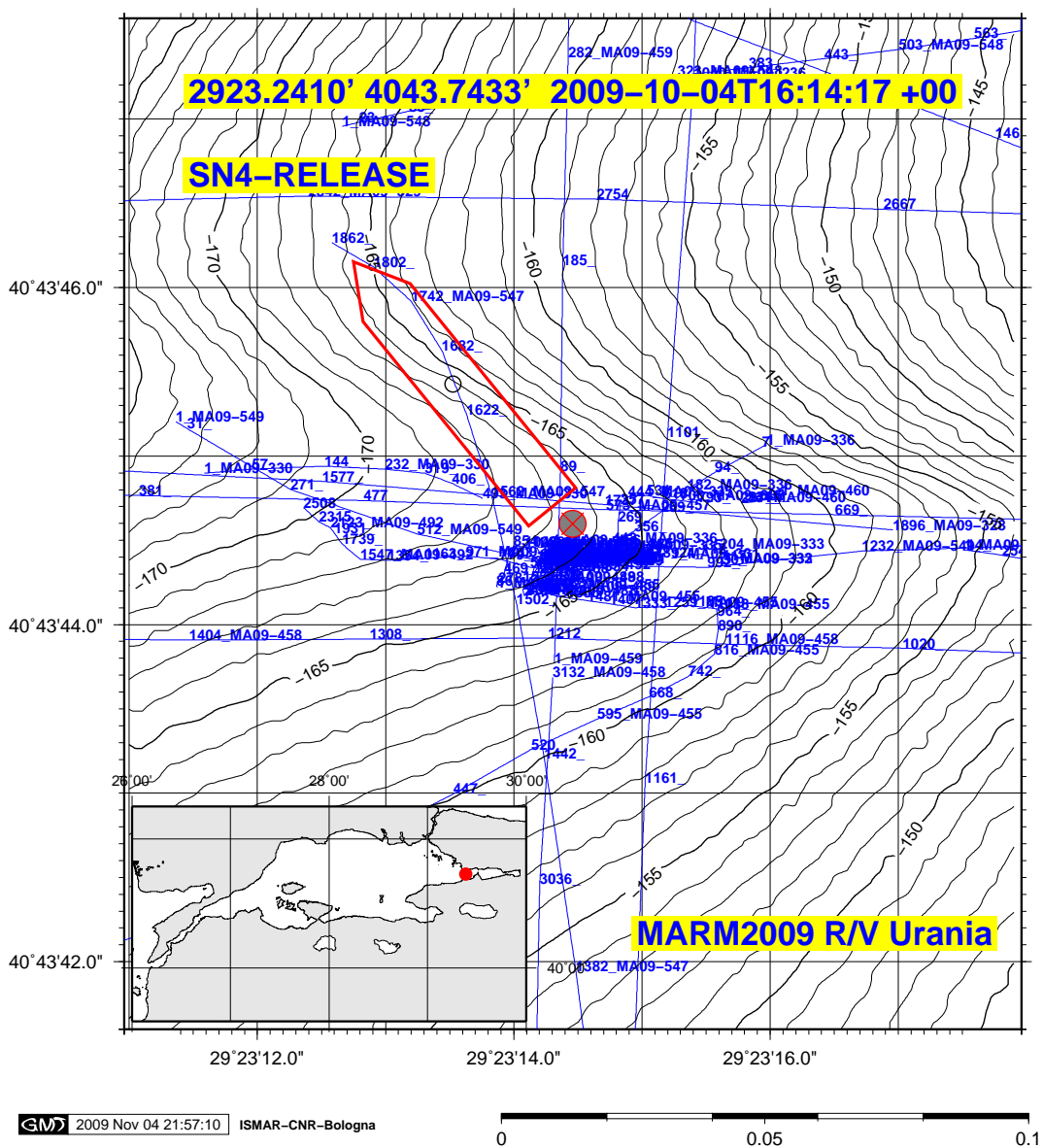

Figure 62: SN4-RELEASE positioning data.

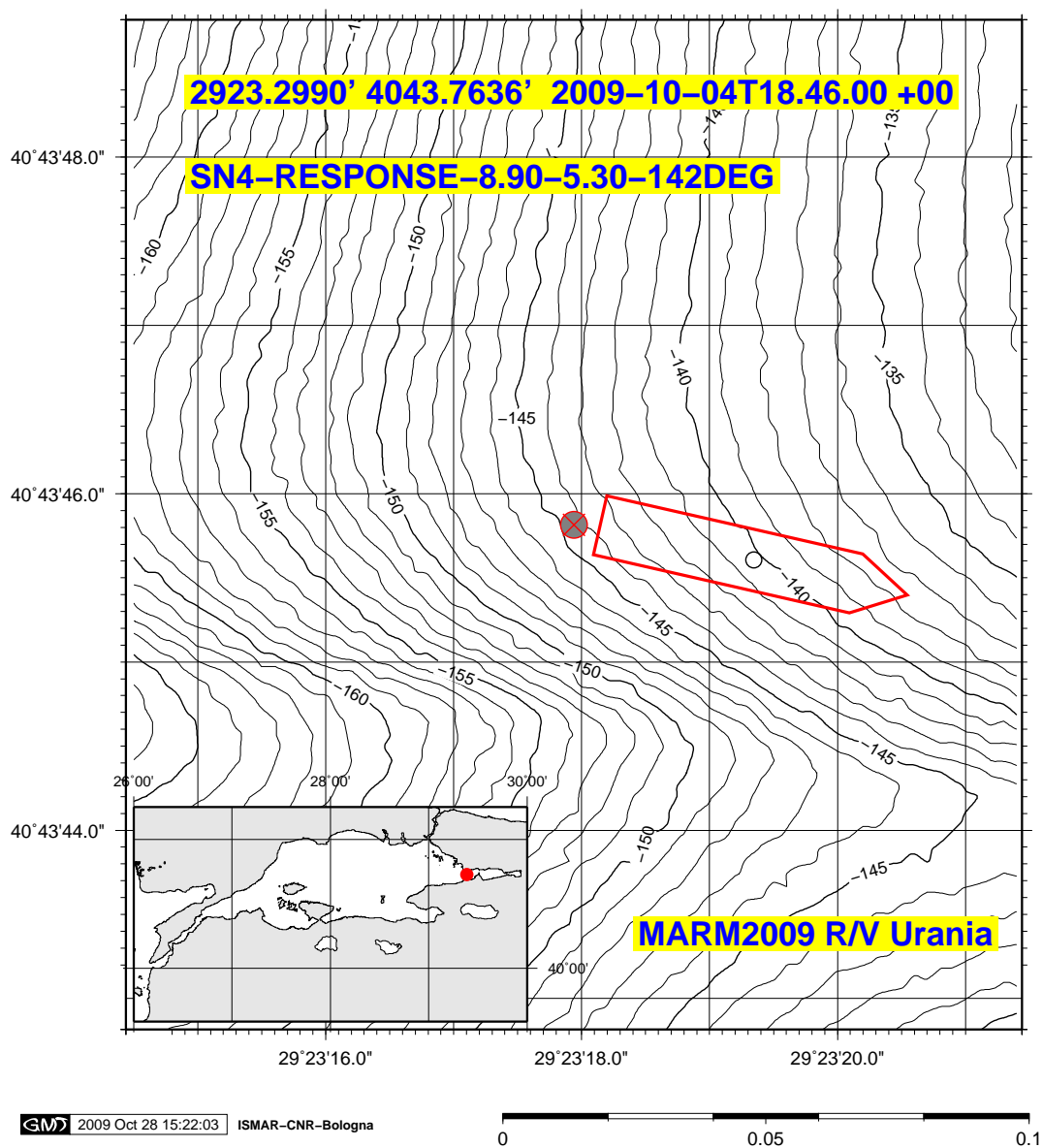

Figure 63: SN4-RESPONSE-8.90-5.30-142DEG positioning data.

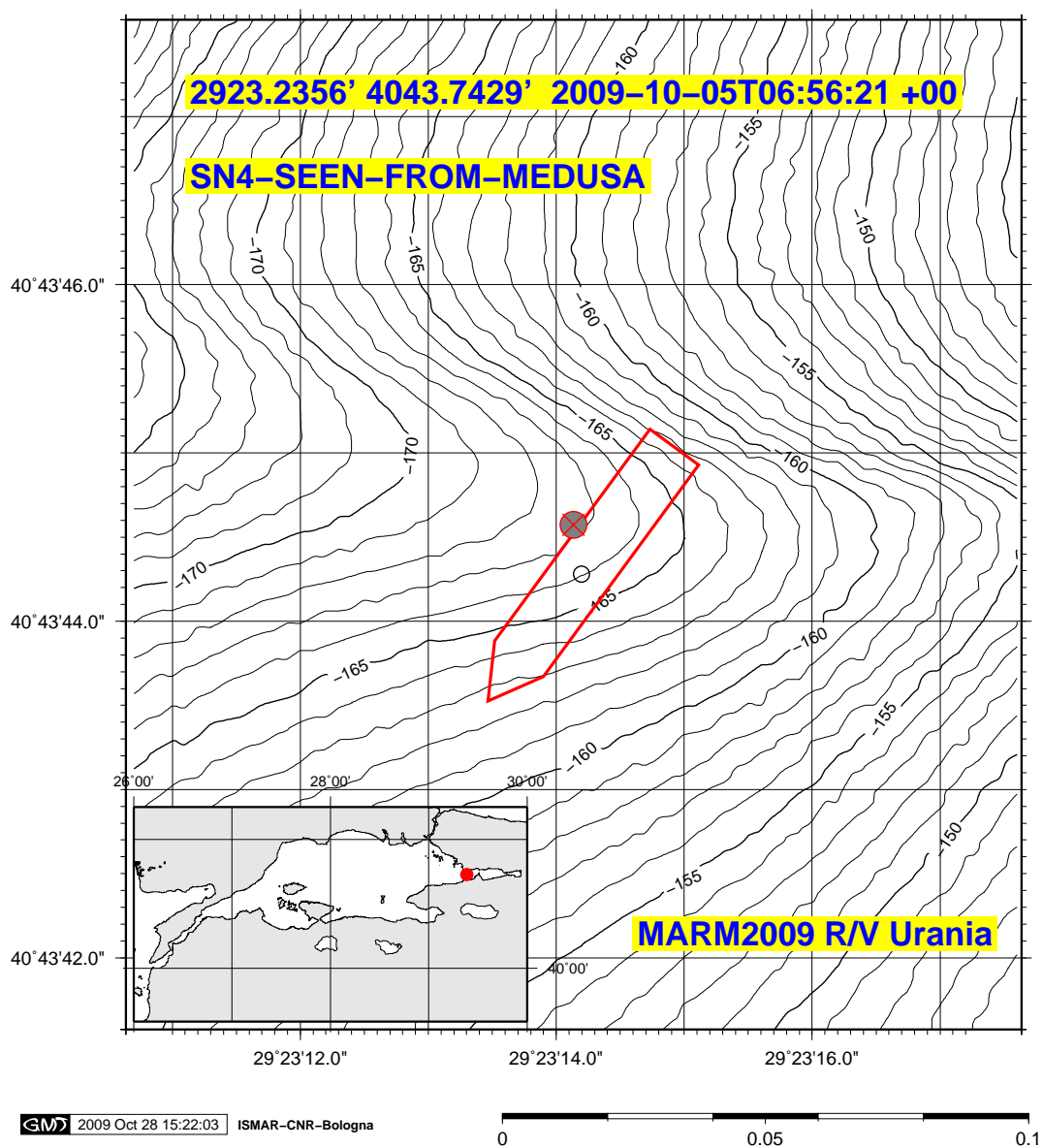

Figure 64: SN4-SEEN-FROM-MEDUSA positioning data.



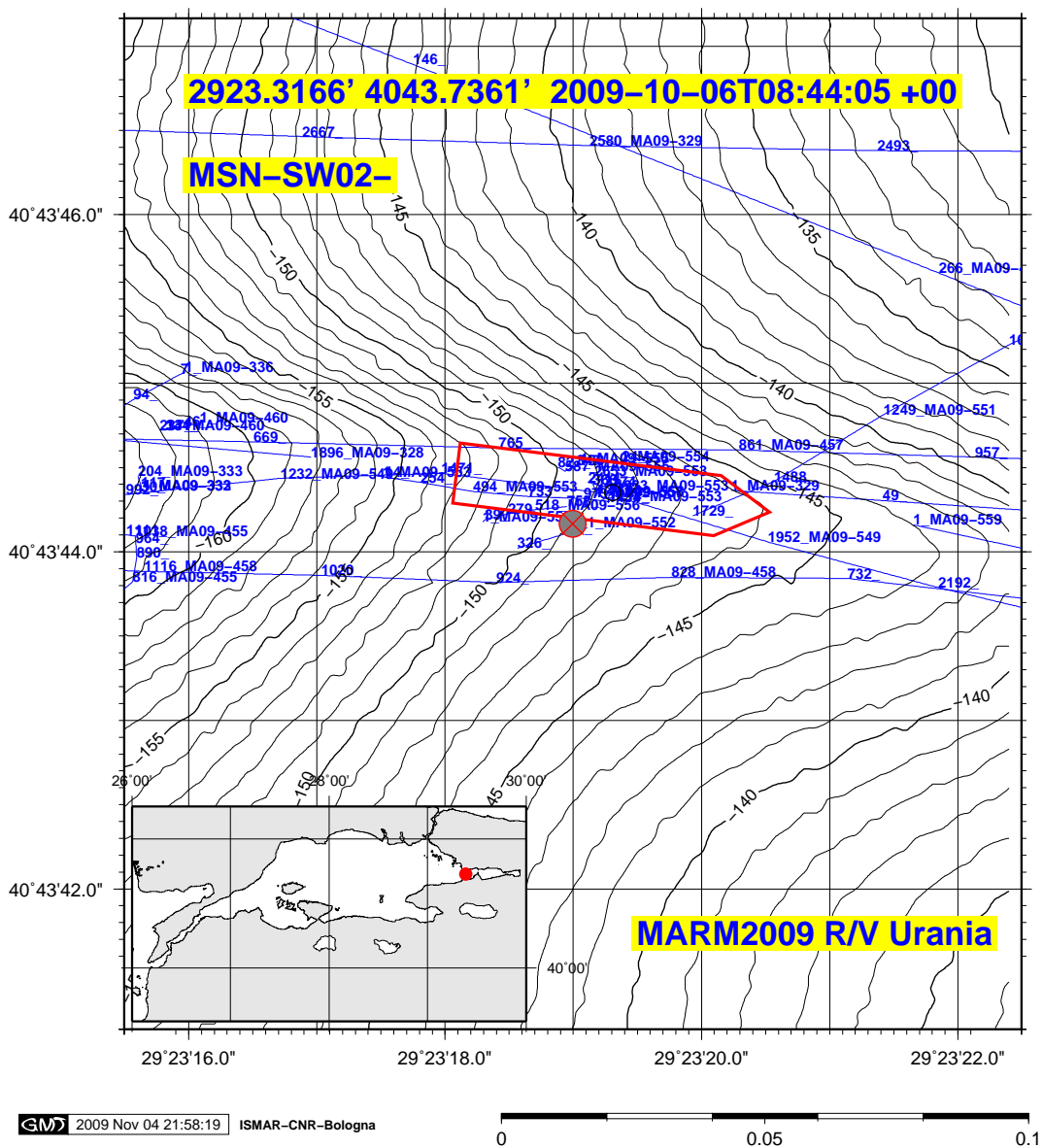

Figure 66: MSN-SW02- positioning data.



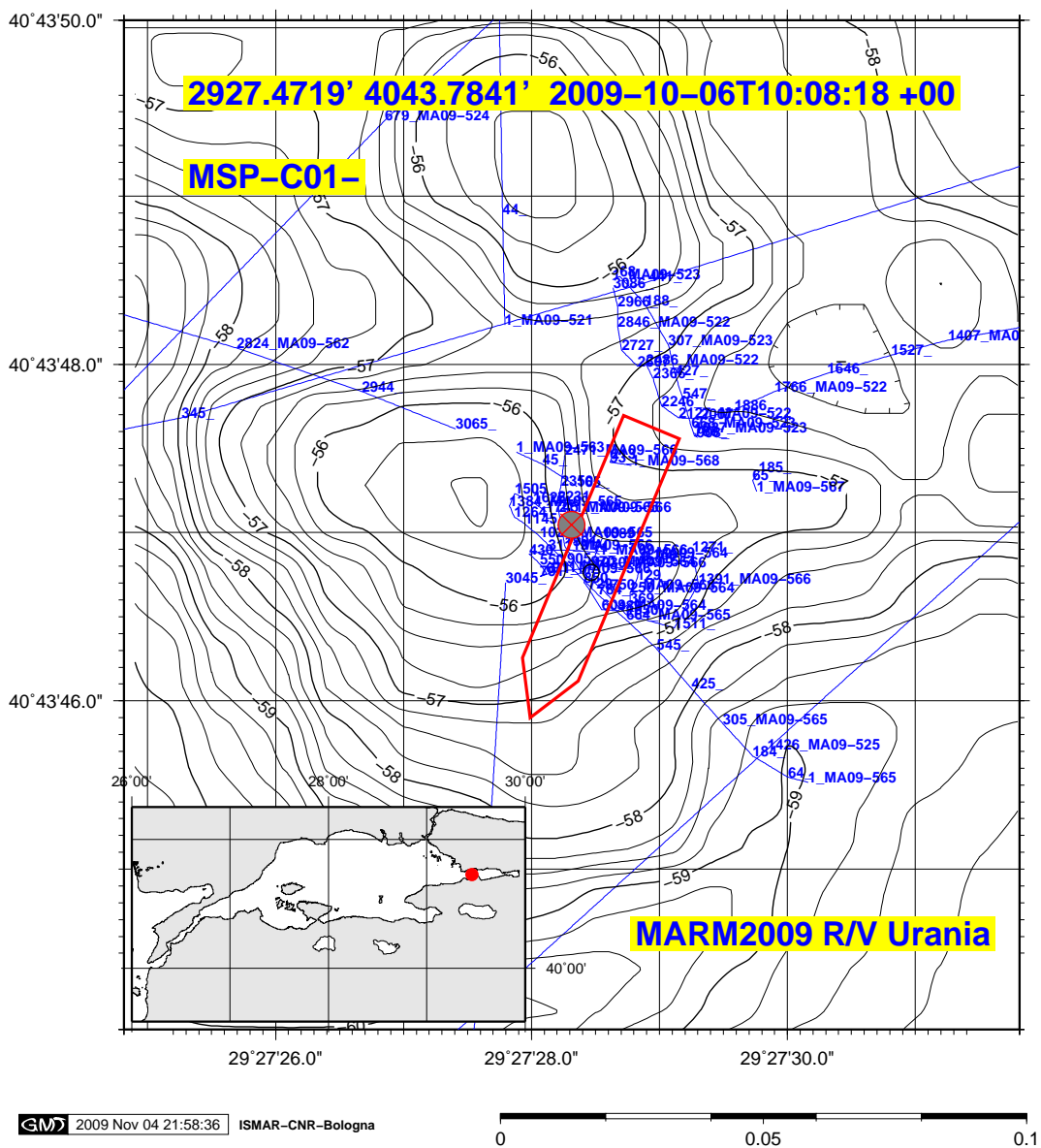

Figure 67: MSP-C01- positioning data.

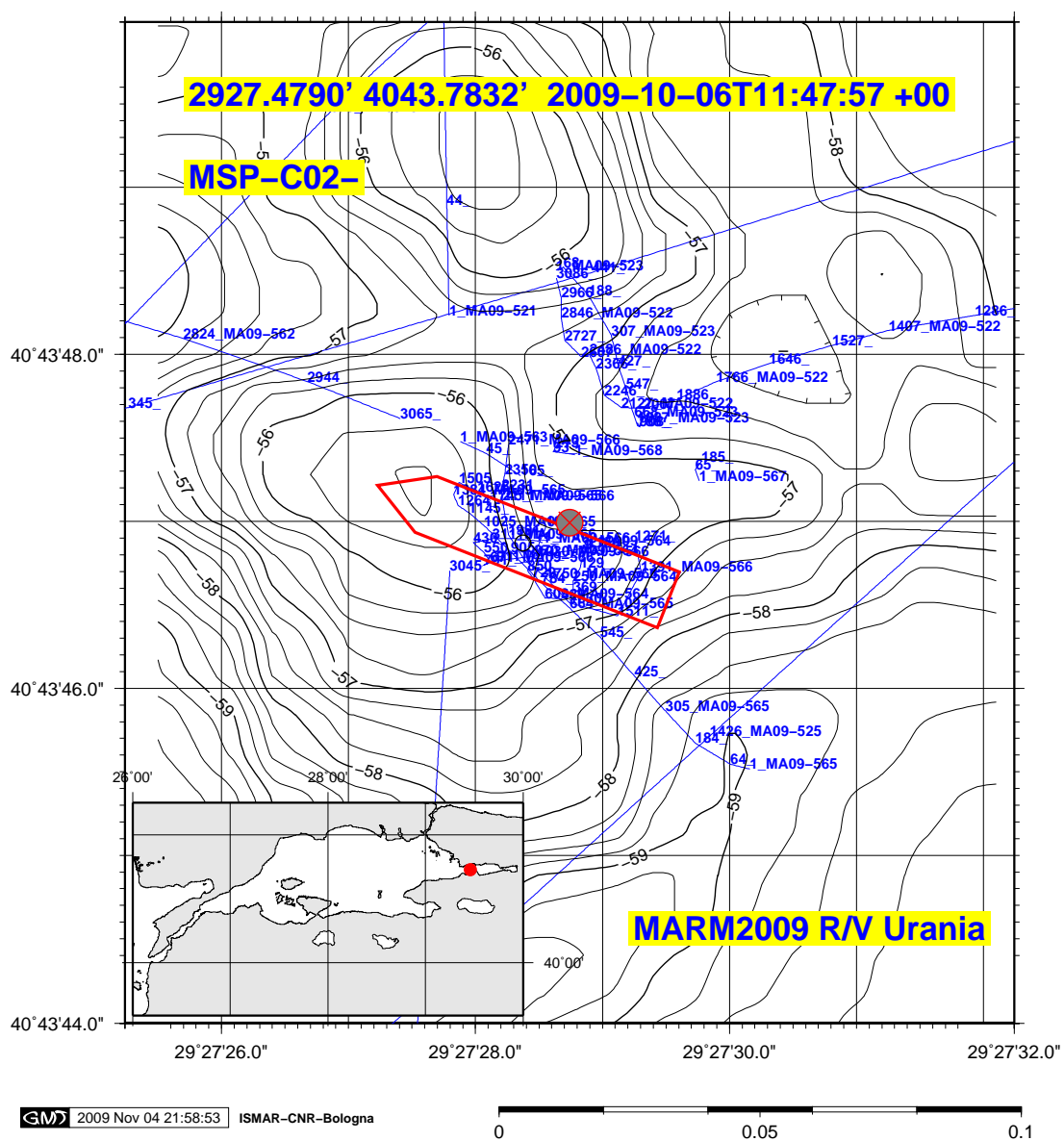

Figure 68: MSP-C02- positioning data.

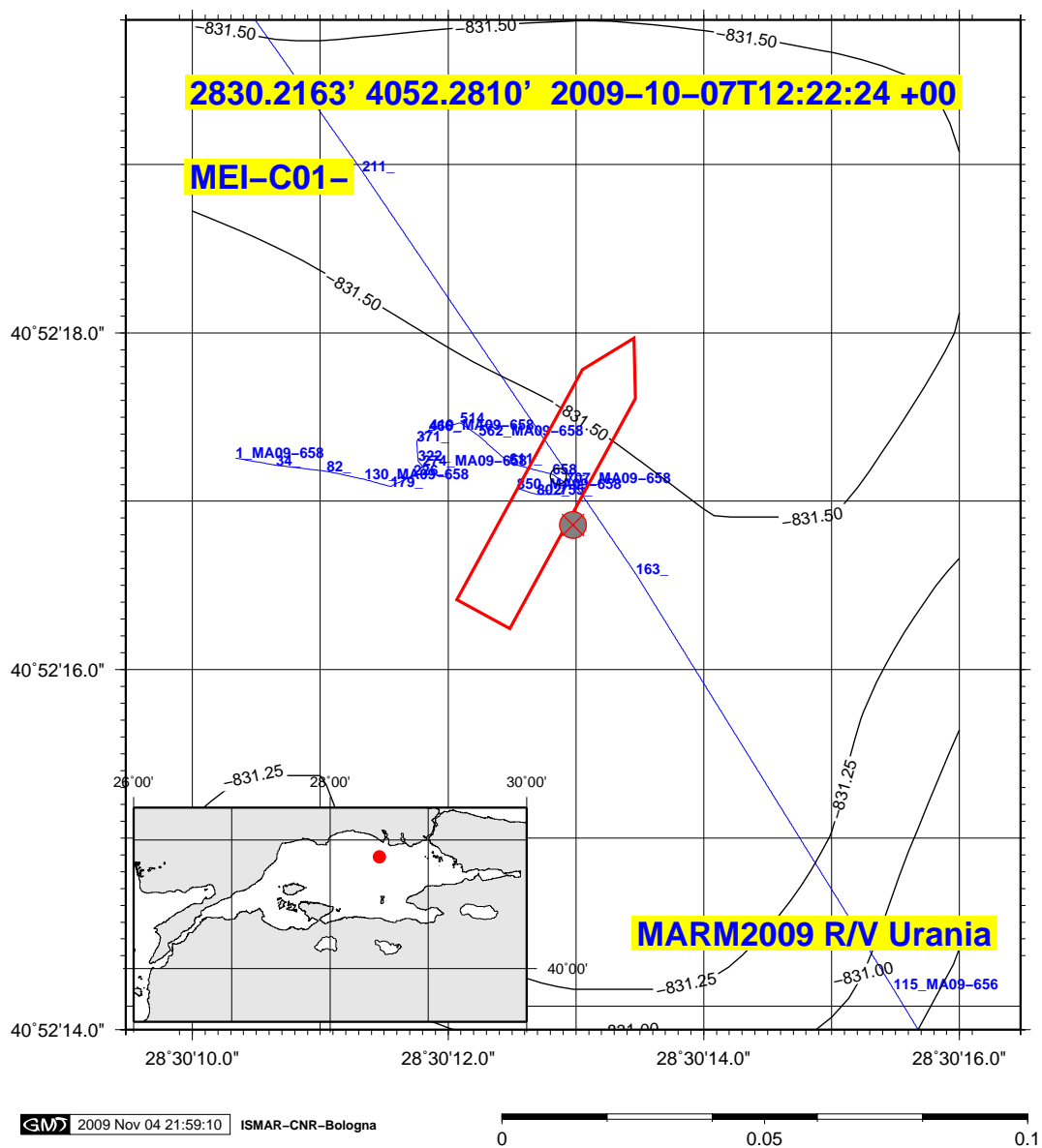

Figure 69: MEI-C01- positioning data.

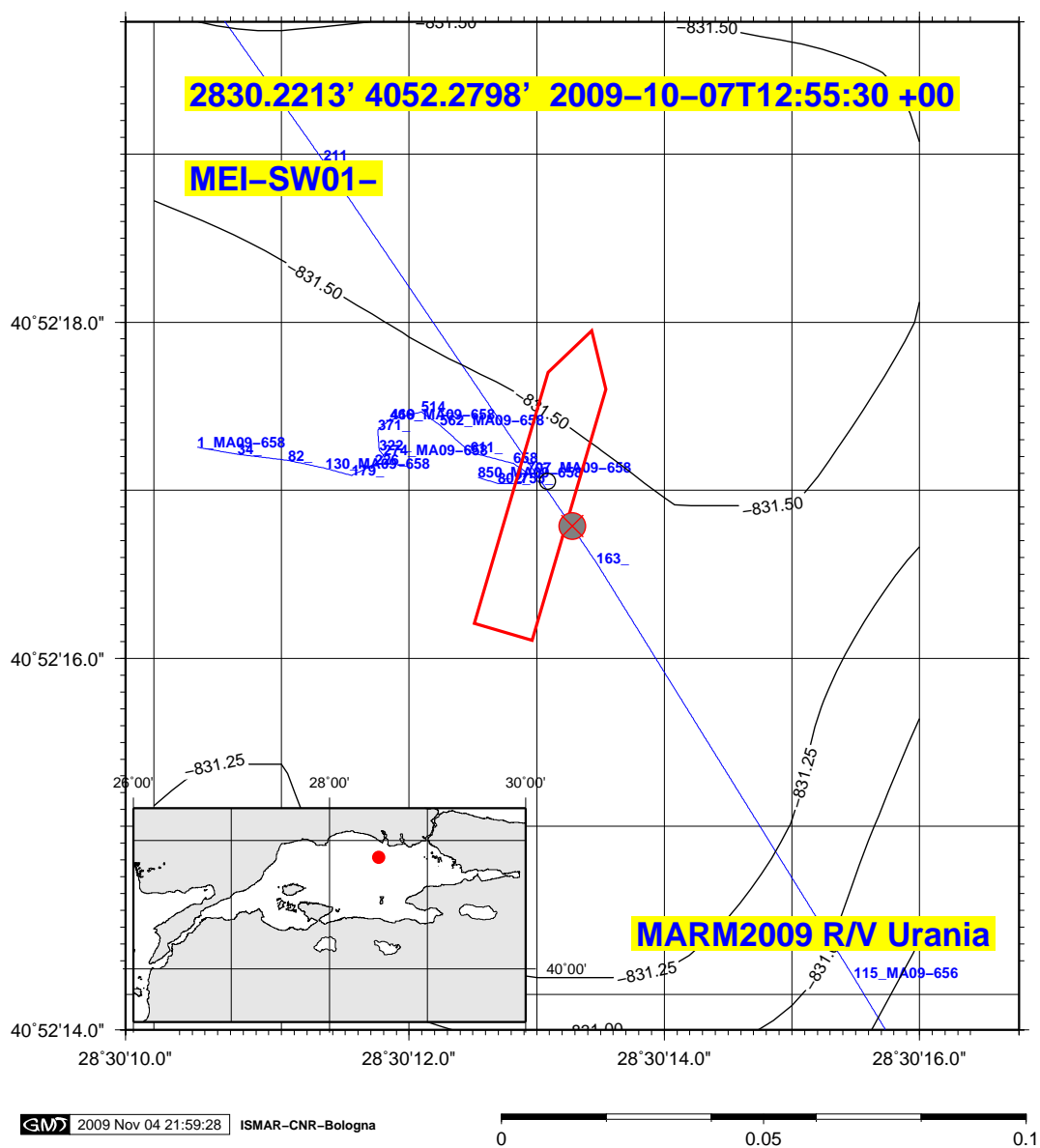

Figure 70: MEI-SW01- positioning data.

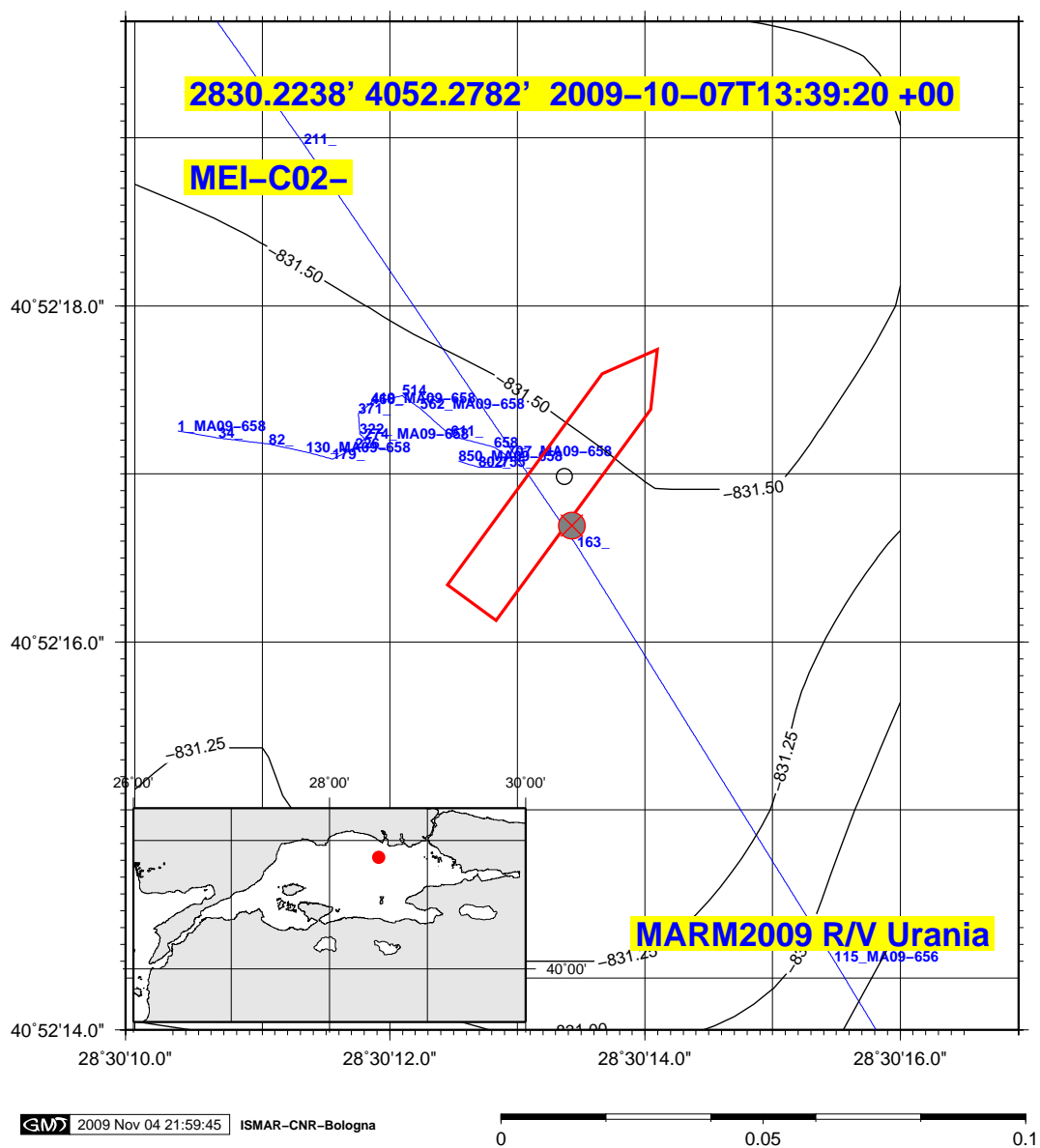

Figure 71: MEI-C02- positioning data.

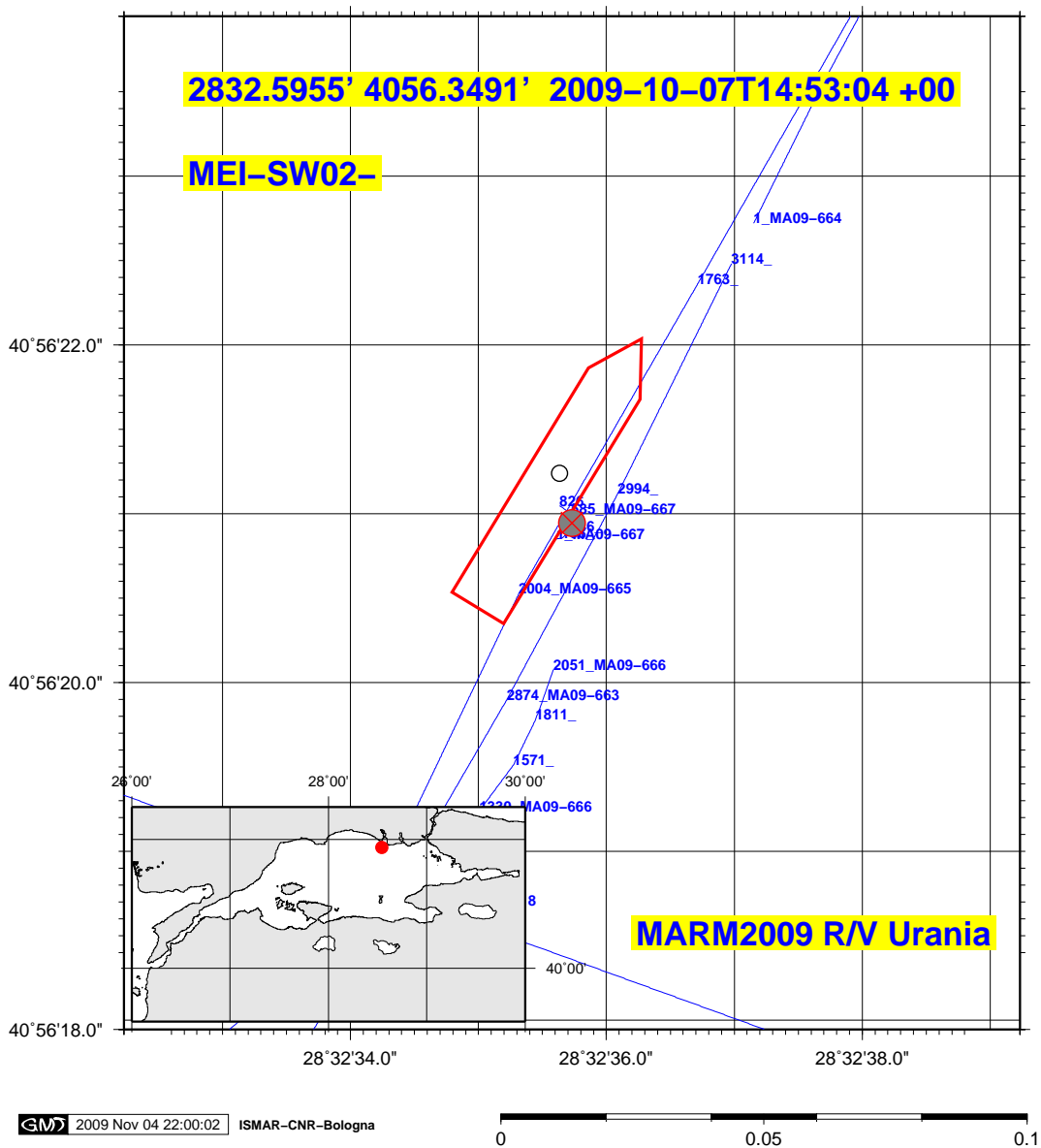

Figure 72: MEI-SW02- positioning data.